

MILLIVOLT SWITCH LIGHTING AND OPERATION "S"

NOTE: The **Valve Knob** has complete control of gas to pilot and burner. The **Valve Knob** cannot be turned to "OFF" without first depressing knob in "PILOT" position and then rotating clockwise to "OFF".

STEP ONE: Pilot Lighting (Remote Valve):

1. Depress and turn **Valve Knob** clockwise to "OFF" position. (Figure 1)
2. Set Accessory Control (Figure 4) to "OFF" (Switch or Remote Control) or to lowest temperature setting (Thermostat)
3. Wait at least 5 minutes to allow gas which may have accumulated around burner to escape.
4. Turn **Valve Knob** counter clockwise to "PILOT" position. (Figure 2)
5. Depress and hold **Valve Knob** until air is bled and gas flows to pilot.
6. Light pilot (Figure 21). Continue to hold in the **Valve Knob** until the pilot flame remains lit when knob is released (approximately 60 to 90 seconds). If Pilot does not remain lit, repeat steps 1 through 5 and allow more time after pilot lighting before releasing knob.
7. Turn **Valve Knob** to "ON". (counter clockwise Figure 3) (Black terminal wire removed to allow unobstructed view)

FIGURE 1



FIGURE 2

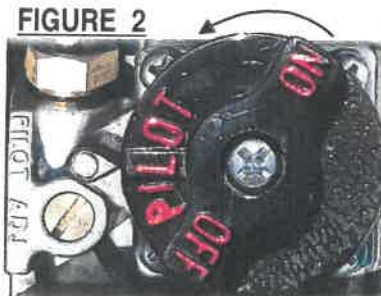
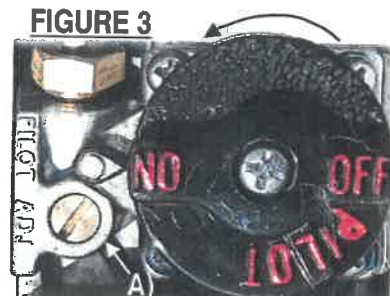

FIGURE 3



ADJUSTING BURNER FLAME HEIGHT USING THE REMOTE VALVE

Flame size at the burner is adjustable at the **Gas Valve Knob**. Turn the **Valve Knob** counter clockwise for more flame, clockwise for less flame.

For **Complete Shutdown (Including Pilot)**: Slightly push and turn **Valve Knob** to "OFF".

Switch Accessory Wiring: Wiring from the Accessory Control (Remote, Thermostat or Switch) is connected to the **outside terminals** (Figure 5A and 5B) of the **Control Selector Switch** (Figure 4 and Figure 5C).

NOTE: Wire length for Thermostat, Remote or Controls should no exceed 20 feet. Thermostat wiring should be 20 AWG Type CL2

Switch Accessory Operation: Place the **Control Selector Switch** (Figure 19) in the "REMOTE ACCESS ON" position. Burner "ON" or "OFF" is now controlled by the position of the accessory control being used with the burner. Individual operating instructions for each Remote Accessory Option are included with the accessory.

FIGURE 4

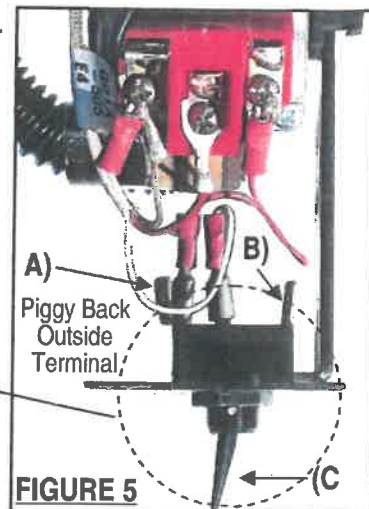
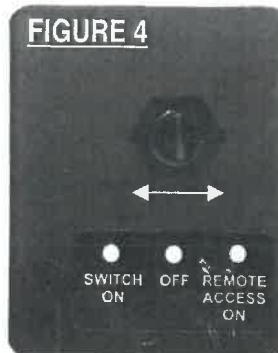
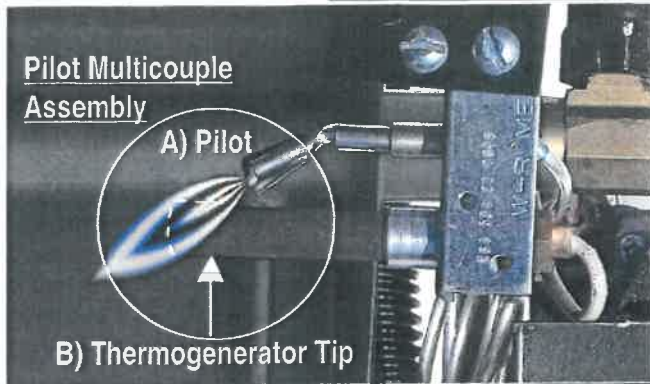

FIGURE 6

STEP TWO: PILOT ADJUSTMENT (Switch and Remote Valve)



1. The Pilot flame should be steady and soft blue, surrounding the **THERMOGENERATOR TIP** (Figure 6B).
2. If pilot flame adjustment is necessary, use a narrow long stem flathead screwdriver to turn **PILOT ADJUSTMENT SCREW** (Figure 1A) above.
3. Turn clockwise for less flame, counterclockwise for more.
4. If after pilot adjustment the burner begins to shutdown, re-adjust for a longer pilot flame.

Connecting Accessory Controllers: Using the 20' accessory control wiring attached to the two **outside terminals** of the valve block (Figure 5A and 5B), connect the **Switch Control Accessory Option** (Remote, Thermostat, Switch, etc.) to valve.

REMOTE RECEIVER PLACEMENT

The Remote Receiver (Figure 7A (This remote system is sold separately) can be adversely affected by heat and must be placed as **far forward and to the side of your CHILBUSTER™** as possible (Figure 7). Our optional **Ceramic Log House** accessory (RH2) (Figure 7B), offers heat protection for the Remote Receiver while being pleasing to the eye. Also sold separately, is our "Stand Alone Crackler" (CH) which mimics the sound of a crackling fire adding a cozy feel to your log set.

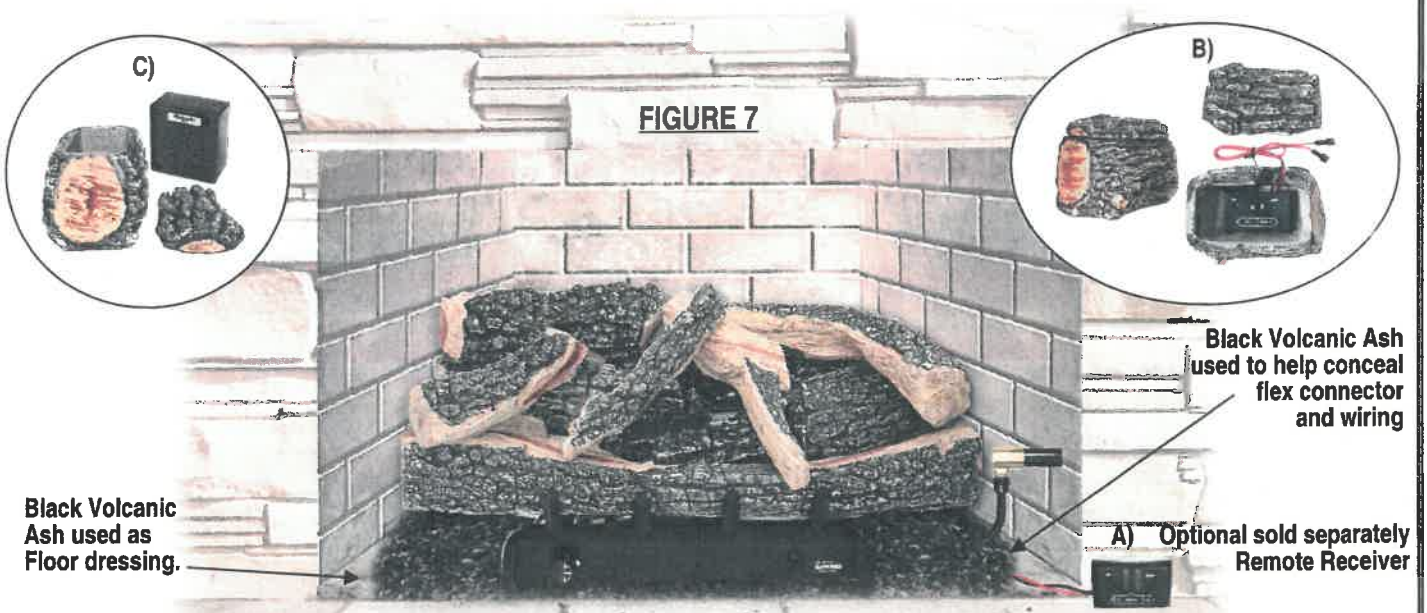

WARNING: Failure to position the parts in accordance with these diagrams or failure to use only parts specifically approved with this heater may result in property damage or personal injury.



Wireless "ON/OFF" remote control transmitter and receiver. (SR-MV1); Sold Separately.



Wireless "ON/OFF" remote control with thermostatic and countdown timer features. (THR-MV1)

ALTERNA™ VF Contemporary Gas Heater



Report #10-36

Mass Approval Code:
G1-0416-463



Rasmussen®
THE GAS LOG COMPANY

General Assembly, Installation, and Operation Instructions

12028 E. PHILADELPHIA ST.
WHITTIER, CA 90601 U.S.A.
www.rasmussen.biz

ATTENTION! READ INSTRUCTIONS CAREFULLY BEFORE ASSEMBLY OR USE

Models: AFB (20, 24, 30) - (ME, SE, RE; S, EI) - (N, P)
AFS (20, 24, 30) - (ME, SE, RE; S, EI) - (N, P)

AFG (20, 24, 30) - (ME, SE, RE; S, EI) - (N, P)

WARNING: If the information in this manual is not followed exactly, a fire or explosion may result causing property damage, personal injury or loss of life.

— Do not store or use gasoline or other flammable vapors and liquids in the vicinity of this or any other appliance.

— WHAT TO DO IF YOU SMELL GAS

- Do not try to light any appliance.
- Do not touch any electrical switch; do not use any phone in your building.
- Immediately call your gas supplier from a neighbor's phone. Follow the gas supplier's instructions.
- If you cannot reach your gas supplier, call the fire department.

— Installation and service must be performed by a qualified installer, service agency or the gas supplier.

This is an unvented gas-fired heater. It uses air (oxygen) from the room in which it is installed. Provisions for adequate combustion and ventilating air must be provided. Refer to page 4.

INSTALLER: Leave this manual with the appliance.
CONSUMER: Retain this manual for future reference.

This appliance may be installed in an aftermarket, permanently located, manufactured (mobile) home, where not prohibited by local codes.

This appliance is only for use with type of gas indicated on the rating plate. This appliance is not convertible for use with other gases. Field conversion is not permitted. Gas type conversion may only be accomplished at the factory. Please contact Rasmussen for details.

Installation must conform with local codes or, in the absence of local codes, with the National Fuel Gas Code, ANSI Z223.1/NFPA 54.

WARNING

This appliance is for installation only in a solid-fuel burning masonry or *UL 127* factory-built fireplace or in a listed ventless firebox enclosure. It has been design certified for these installations. Exception: DO NOT install this appliance in a factory-built fireplace that includes instructions stating it has not been tested or should not be used with unvented gas logs.

In the Commonwealth of Massachusetts:

- Installation must be performed by a licensed plumber or gas fitter.
- The chimney flue damper, when used with gas logs, will be welded open or completely removed.
- A CO detector shall be installed in the room where the appliance is installed.

IMPORTANT:

An unvented room heater having an input rating of more than 10,000 Btu per hour shall not be installed in a bedroom or bathroom. Do not install this appliance in a bedroom or bathroom.

The Minimum Fireplace Size (in inches) in which this ALTERNA VF set is to be installed must be as follows:

Set Size	Model Number	BTU/hour	Front Width	Rear Width	Depth	Height
20	AFB20-ME,SE,RE; S, EI- (N,P)	30,000	26	20	11	16
24	AFB24-ME,SE,RE;S EI - (N,P)	40,000	30	24	11	16
30	AFB30-ME,SE,RE; S, EI- (N,P)	40,000	36	30	11	16

ALTERNA VF Contemporary Gas Heaters are certified to the following standards:

- UNVENTED ROOM HEATER ANSI - Z21.11.2
- VENTED DECORATIVE APPLIANCE - ANSI Z21.60; CSA 2.26

IMPORTANT INFORMATION

- **Due to high temperatures**, the appliance should be located out of traffic and away from furniture and draperies.
- **Children and adults** should be alerted to the hazard of high surface temperatures and should stay away to avoid burns or clothing ignition.
- **Young children** should be carefully supervised when they are in the same room with the appliance.
- **Do not place** clothing or other flammable material on or near the appliance.
- **Any safety screen** or guard removed for servicing an appliance must be replaced prior to operating the heater.
- **Installation and repair** should be done by a qualified service person. The appliance should be inspected before use and at least annually by a professional service person. More frequent cleaning may be required due to excessive lint from carpeting, bedding material etc. It is imperative that control compartments, burners and circulating air passageways of the appliance be kept clean.
- **WARNING:** Any change to this heater or its controls can be dangerous.
- **This appliance** is intended for supplemental heating. It should not be used as a primary heat source for a dwelling.
- **WARNING:** Failure to keep the primary air opening(s) of the burner clean may result in sooting and property damage.
- **Keep appliance area** clear and free from combustible materials, gasoline and other flammable vapors and liquids.
- **DO NOT** use this room heater if any part has been under water. Immediately call a qualified service technician to inspect the room heater and to replace any part of the control system and any gas control that has been under water.
- **WARNING:** Before installing in a solid-fuel burning fireplace, the chimney flue and firebox must be cleaned of soot, creosote, ashes and loose paint by a qualified chimney cleaner.
- **WARNING:** Do not allow fans to blow directly into the fireplace. Avoid any drafts that alter burner flame patterns.
- **WARNING:** Do not use a blower insert, heat exchanger insert or any other accessory not approved for use with this heater.
- **A fireplace screen** must be in place when the appliance is operating and, unless other provisions for combustion air are provided, the screen shall have an opening(s) for introduction of combustion air.
- **Solid fuels** shall not be burned in a fireplace where this ALTERNA VF heater is installed.
- **WARNING:** Glass doors must be fully opened when appliance is in operation to allow for safe combustion, cooling of components and venting.
- **Any outside air ducts** and/or ash dumps in the fireplace shall be permanently closed at the time of appliance installation.
- **State or local codes** may only allow operation of this appliance in a vented configuration. Check your state or local codes.
- **DO NOT** use this appliance, in the vent-free application, in sleeping quarters, bathrooms or recreational vehicles. This appliance may be used in sleeping quarters and bathrooms if used in a vented application, subject to local codes.
- **Avoid contact** with the objects, chassis or another part which may be hot during operation.
- **This appliance is equipped** with an ODS (Oxygen Depletion Sensor) pilot light safety system, which is designed to shut the appliance off in the absence of inadequate fresh air. Additional ventilation may be obtained by opening a window an inch or two, or a door to another room. See Page 23 for nuisance shutdown issues and correction.

CARBON MONOXIDE POISONING MAY LEAD TO DEATH

When used without fresh air, decorative gas appliances may give off carbon monoxide, an odorless, colorless, poisonous gas. Some people, pregnant women, persons with heart or lung disease, anemia, persons under the influence of alcohol and persons who live at high altitudes are more affected by carbon monoxide than others.

Early signs of carbon monoxide poisoning resemble the flu and include; headache, dizziness and/or nausea. If you have these symptoms, the burner or the appliance may not be installed or working properly, or the flue may be blocked. **GET FRESH AIR AT ONCE!** Verify that the gas log set is properly arranged and have the heater and chimney flue serviced before using again.

WARNING

During manufacturing, assembly and packaging, various components of ALTERNA™ are exposed to certain oils or films. These are not harmful but may produce annoying smoke and smells as they are burned off during the initial operation of the appliance, possibly causing headaches, eye or lung irritation. This is a normal occurrence and only temporary. The initial break-in operation should last 2-3 hours with the burner at the highest setting. Provide maximum ventilation by opening windows, doors and the chimney flue (if using a vented model) to allow odors to dissipate. The only odor remaining after this initial break-in period will be the normal odors associated with the combustion of Natural or Propane Gas and/or related to your indoor environment (see page 23).

WARNING—Proposition 65 Statement

If not installed, operated and maintained in accordance with these instructions, this product could expose you to substances in fuel or from fuel combustion which are known to the State of California to cause cancer, birth defects or other reproductive harm.

PARTS LIST

REQUIRED TOOLS AND MATERIALS

Adjustable Wrench and Pipe Wrench. Pipe joint compound or Teflon tape is **required** for all threads (except flared threads).

- | | | |
|--|--|--|
| 1. Valve Knob Extender "ME" Models (STV-KE2) | 9. Regulator (Natural Gas - R1-3.5
Propane - R1-10.5) | 18. Damper Stop Clamp (DC1) |
| 2. "EASY" Safety Valve Knob | 10. Burner (18"- CH5-RB, 24"-022AR, 30"-023) | 19. Black Volcanic Ash (VA5) (available separately) |
| 3. Valve Plug ("ME" Models) (also used when replacing, servicing or upgrading.)
Location for; | 10A Pilot Location | 20. Rating Plate |
| 3A Remote Ready Solenoid (-SE Models) (STV-LS) | 10B Pilot ODS(see page 20) | 21. Warning Plate |
| 3B Variable Flame Height Motor drive (-RE Models) (STV-VMD) | 11. 3/8" Gas Output Tubing | 22. Wireless Remote Transmitter Devices
For "-SE" Models (each sold separately) |
| 4. "EASY" Safety Valve (STV-10) | 12. Orifice Holder | a. Wireless Hand-Held ON/OFF Remote (SR-2R) |
| 5. 1/4" Pilot Tubing (length varies with set size) | 12A Orifice Spud - (O1—varies with size & gas) | b. Wireless Hand Held ON/OFF Remote with
Thermostat (THR-2R) |
| 6. 3/8" x 3/8" Street Elbow (A2) | 13. Piezo Push Button Igniter | c. Wireless Wall Timer (30/60/120 Minutes) (WT-2R) |
| 7. Thermocouple Wire | 13A Piezo Wire | d. Wireless Wall Switch (WS-2R) |
| 8. Gas Supply Input—3/8" flare | 14. Base support | e. Wireless Wall Thermostat (TS-2R) |
| | 15. 3/8" Gas Input Tubing | 23. Wireless Hand Held Variable Remote for "-RE"
Models (STR-RMD) |
| | 16. Flex Connector (SSCB-18) | 24. Remote Receiver for "-SE" or "-RE" (BPR3) |
| | 17. 3/8" x 1/2" FIP EL (A1) | |

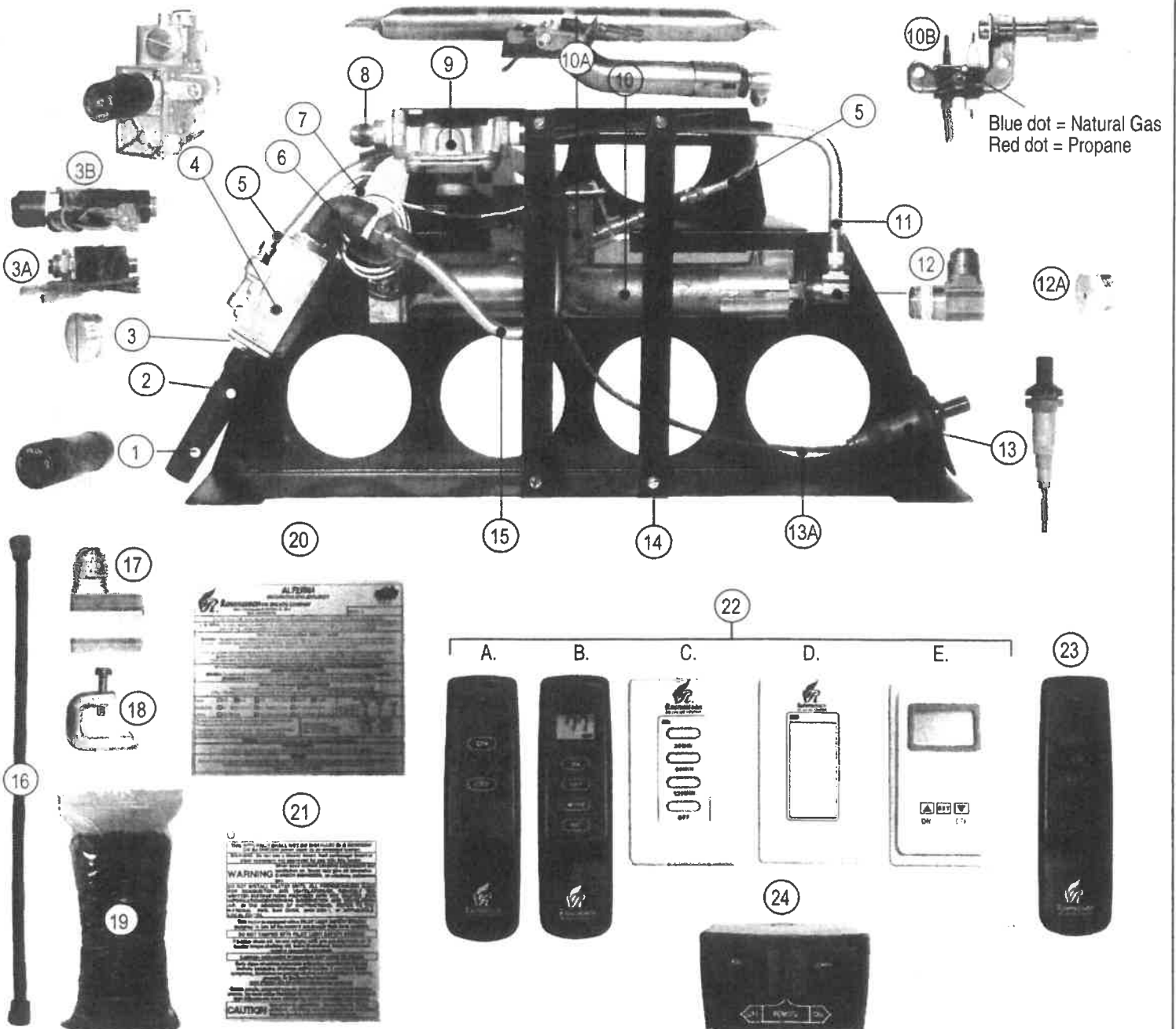

WARNING: Any change to this appliance or its controls can be dangerous

VENT FREE APPLICATIONS • SPACING CALCULATIONS

This heater shall not be installed in a "confined" space or unusually tight construction unless provisions are provided for adequate combustion and ventilation air.

The "**National Fuel Gas Code, ANSI Z223.1/NFPA 54**" defines a confined space as a space whose volume is less than 50 cubic feet per 1000 Btu per hour (4.8 m³ per kW) of the aggregate input rating of all appliances installed in that space and an unconfined space as a space whose volume is not less than 50 cubic feet per 100 Btu per hour (4.8 m³ per kW) of the aggregated input rating of all appliances installed in that space. Rooms communicating directly with the space in which the appliances are installed, through openings not furnished with doors, are considered a part of the unconfined space.

Calculations to Determine Confined or Unconfined Space:

1. Determine number of rooms (including adjoining rooms with odorless passageways or ventilation grates.)

Example: Living room/Dining Room + Kitchen

2. Determine the Total Volume of the Space (Width x Length x Height).

Example: Living room/Dining Room 14' x 20' x 8' = 2240 cu ft.

Kitchen 8' x 12' x 8' = 768 cu ft.

Total Volume of Space 3008 cu ft.

3. Divide the total volume of space by 50 cu ft to determine the **Maximum Supportable Btu/Hr.**

Example: 3008 cu ft ÷ 50 = 60.160 x 1000 = 60,160

Maximum Supportable Btu/Hr. = 60,160 Btu/Hr.

4. Add the rated (Btu/hr) of all fuel burning appliances in the "space" to determine **Actual Btu/Hr. used.**

Example: Vent free gas log heater 40,000 Btu/Hr.

+ Gas water heater 32,000 Btu/Hr.

= Actual Btu/Hr. Used 72,000 Btu/Hr.

Note: Do not include direct vent gas appliances.

5. Compare **Maximum Supportable Btu/Hr** to **Actual Btu/Hr Used.**

- If the **Actual Btu/Hr used.** is greater than the **Maximum Supportable Btu/Hr.** then the space is **CONFINED.**
- If the **Actual Btu/Hr used.** is **less than** the **Maximum Supportable Btu/Hr.** then the space is **UNCONFINED.**

Example: Maximum Supportable Btu/Hr = 60,160 Btu/Hr.

Actual Btu/Hr. Used = 72,000 Btu/Hr.

Difference = 11,840 Btu/Hr. = Excess Non-Supportable Btu/Hr.

Because the **Actual Btu/Hr used** Exceeds the **Maximum Supportable Btu/Hr** in this example, the space is considered a **Confined Space** requiring you to either increase the **Maximum Supportable Btu/Hr** by the difference, in this case 11,840 Btu/Hr. or decrease the **Actual Btu/Hr used** by the same amount. You may also choose to operate your ALTERNA™ as a Vented Appliance instead. (See notes and warnings regarding vented installation on Page 7)

Adequate Combustion And Ventilation Air Options:

- Increasing the **Maximum Supportable Btu/Hr.**
 1. Add to the number of rooms which comprise the "Space". To do this you must either completely remove the door to an adjoining room, or provide two permanent ventilation grills; one within 12" of the ceiling and another within 12" of the floor.
 2. Provide extra fresh air using ventilation grills and ducts to the outdoors. You must provide two permanent openings. One within 12" of the ceiling and another within 12" of the floor. Connect these directly to the outdoors or spaces open to the outdoors, e.g., attics or crawl spaces. If this route is chosen you **MUST** follow the **National Fuel Gas Code NFPA 54/ANSI Z223.1, Section 5.3, Air for Combustion and Ventilation** for required size of ventilation grills or ducts.
- Lower the **Actual Btu/Hr used** by relocating other gas burning appliances outside the "space" or installing a lower Btu/Hr heater. In the example, the maximum Btu/Hr. of the heater could be no more than 28,160 Btu/Hr.

VENT FREE APPLICATIONS • COMBUSTION AIR CALCULATIONS

For our example, we have chosen to add to our **Total Volume of the Space** by removing the door to an adjoining study and increasing our **Maximum Supportable Btu/Hr** by the volume of the additional room. The new "space" calculations, including the additional adjoining room are: *Living room/Dining room & Kitchen 3008 cu ft*

<i>Study (9' x 10' x 8')</i>	<i>720 cu ft</i>
Total volume of space	3728 cu ft

The new **Maximum Supportable Btu/Hr** = $(3728 \text{ cu ft} \div 50 \text{ cu ft}) \times 1000 = 74,560 \text{ Btu/Hr}$

74,560 Btu/Hr = Maximum Supportable Btu/Hr

-72,000 Btu/Hr = Actual Btu/Hr Used

2560 BTU/Hr = Remaining supportable BTU/H

Because the **Actual Btu/Hr** used is now less than the **Maximum Supportable Btu/Hr**, the space is considered an **Unconfined Space**. No additional fresh combustion and ventilation air would be required.

COMBUSTION AIR CALCULATIONS WORKSHEET					
1.	Room	Width	Length	Height	W x L x H = Vol.(ft ³)
1a.					1a.
1b.					1b.
1c.					1c.
1d.					1d.
2.	Total Volume (ft³) The Sum of Volume of all rooms (add lines 1a. thru 1d.).				2.
3.	Max Supportable Btu/Hr = Total Volume (ft ³) ÷ 50 x 1000 (divide line 2. by 50 then multiply by 1000)				3.
4.	4a. Btu/hr	4b. Btu/hr	4c. Btu/hr	4d. Btu/hr	
	Actual Btu/hr used = The sum of Btu/hr of all fuel burning appliances inside the space identified as rooms 1a. thru 1b (add line 4a thru 4d).				4.
5.	(Maximum Supportable Btu/Hr) minus (Actual BTU/hr Used) (Subtract line 4. from line 3.)				5. *

* If Line 5 is greater than zero, the **Actual Btu/Hr Used** is less than the **Maximum Supportable Btu/Hr** and the space is considered **UNCONFINED**. No additional fresh combustion and ventilation is required.

* If Line 5 is zero or less, the **Actual Btu/Hr Used** is greater than **Maximum Supportable Btu/Hr** and the space is **CONFINED**. You must either **increase the Maximum Supportable Btu/Hr**, **decrease the Actual Btu/Hr Used** or **operate as a Vented Appliance** (See notes and warnings regarding vented installation on Page 7).

WARNING:

If the area in which the heater may be operated is smaller than that defined as an unconfined space or if the building is of *unusually tight construction*** , provide adequate combustion and ventilation air by one of the methods described in the National Fuel Gas Code, ANSI Z223.1 / NFPA 54, or applicable local codes.

**Unusually tight construction is defined as construction where:

- a) Walls and ceilings exposed to the outside atmosphere have a continuous water vapor retarder with a rating of 1 perm ($6 \times 10^{-11} \text{ kg per pa-sec-m}^2$) or less with openings gasketed or sealed;
- b) Weather stripping has been added on openable windows and doors; and
- c) Caulking or sealants are applied to areas such as joints around window and door frames, between sole plates and floors, between wall-ceiling joints, between wall panels, at penetrations for plumbing, electrical, and gas lines, and at other openings.

VENT FREE APPLICATIONS • MINIMUM CLEARANCES TO COMBUSTIBLES

When operated as a **Vent Free Heater**, the minimum clearances from the fireplace opening to combustible materials must be maintained as outlined below .

MINIMUM CLEARANCES TO SIDE WALL AND CEILING

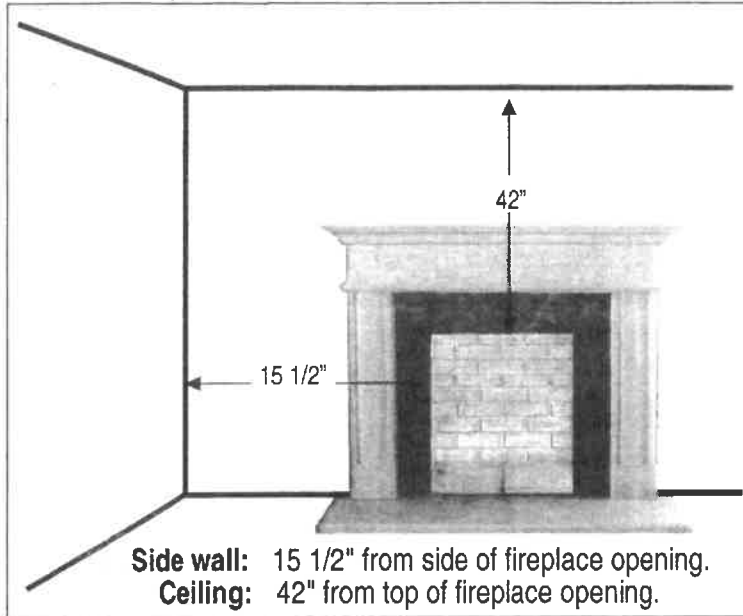

NOTE:

Clearances to Combustible Construction are those distances required to ensure that a fireplace mantel or facing will not catch fire. In most cases they should also be adequate to prevent any discoloration or warping due to heat. However, each and every decorative gas appliance installation (ALTERNA™ included) presents a different and completely unique set of circumstances involving many variables beyond the control of the manufacturer. These include paint or finish composition, previous exposure to heat, methods and quality of construction, air flow patterns, glass doors, fans or blowers, etc. Because of these variables, we cannot guarantee that heat warping or discoloration will never occur. The potential for heat warping or discoloration may exist whether you are burning an ALTERNA™, some other manufacturer's decorative gas appliance or even wood.

MANTEL CLEARANCE WITHOUT HOOD

A fireplace hood deflects heat away from the fireplace face and mantel, reducing the potential for heat related warping or discoloration.

The use of a fireplace hood is highly recommended.*

MANTEL CLEARANCE WITH HOOD

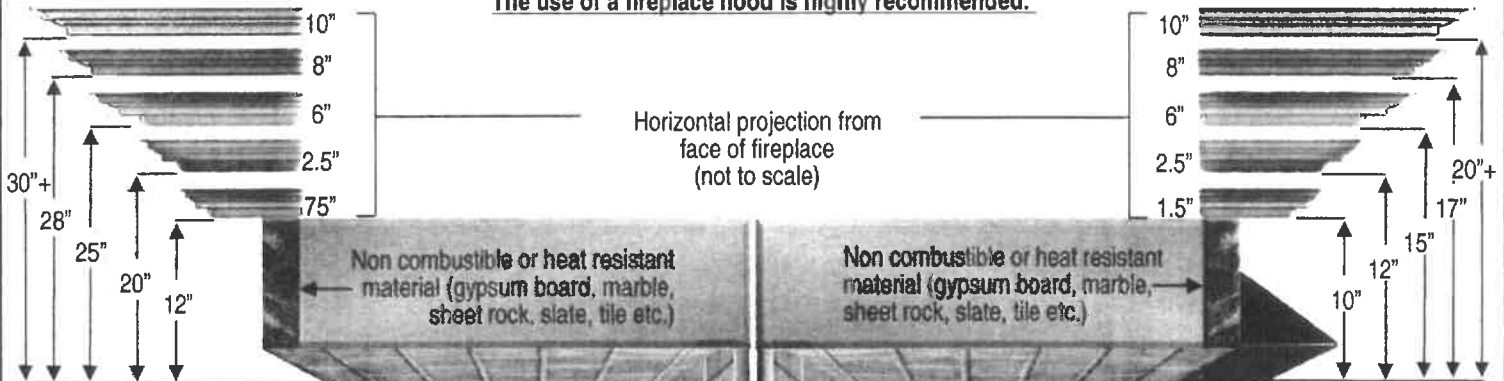

Distances from Top of Firebox Opening to Underside of Mantel

Height Above Opening	Projection Out From Face
0-12"	0"
12"-20"	3/4"
20"-25"	2 1/2"
25"-28"	6"
28"-30"	8"
30" plus	10"

Distances from Top of Firebox Opening to Underside of Mantel

Height Above Opening	Projection Out From Face
0"-10"	0"
10"-12"	1 1/2"
12"-15"	2 1/2"
15"-17"	6"
17"-20"	8"
20" plus	10"

IF YOU CANNOT MEET THESE MINIMUM CLEARANCES YOU MUST OPERATE THE APPLIANCE AS A VENTED APPLIANCE WITH CHIMNEY FLUE DAMPER OPEN. (See notes regarding vented installation on following page)

GENERAL INSTALLATION INSTRUCTIONS

WARNING: Failure to position the parts in accordance with these diagrams or failure to use only parts specifically approved with this heater may result in property damage or personal injury.

The installation and the provisions for combustion and ventilation air must conform with *The National Fuel Gas Code ANSI Z223.1 / NFPA54*, or *The CSA B149.1, Natural Gas and Propane Installation Code*, latest edition.

STEP ONE: PREPARATION (ALL MODELS)

1. Verify that the Valve Assembly is correctly matched to the set, burner, and gas supply.
2. Insure that **Fireplace Gas Supply** is off (Figure 1A).
3. Thoroughly clean fireplace floor of any ashes and have a qualified chimney cleaner insure that the chimney flue and firebox are free of soot, creosote, ashes and loose paint.
4. (**VENTED INSTALLATIONS ONLY**) Attach **Damper Clamp** (Figure 2A) over edge of fireplace **Damper Blade** (Figure 2B) to prevent damper from closing accidentally. If unable to attach damper clamp, drill a hole (or holes) in the damper or remove it completely.

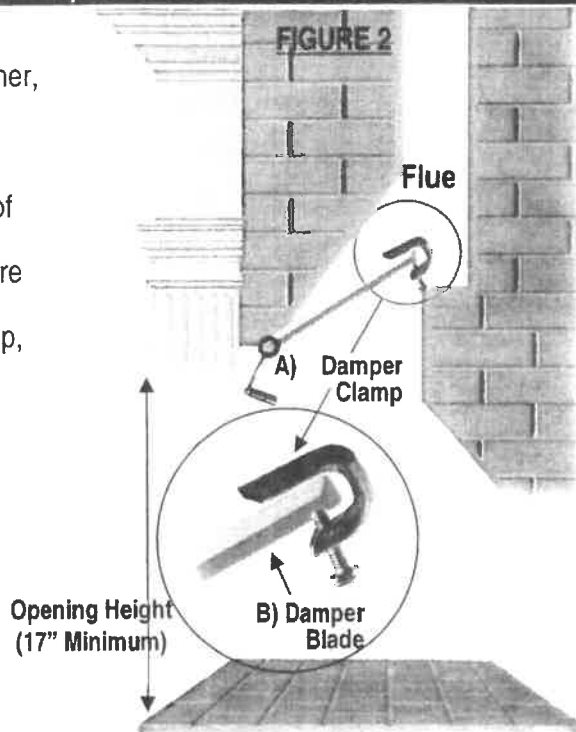
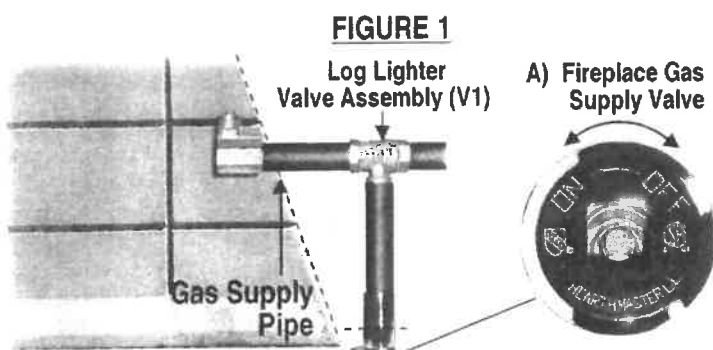

The minimum permanent free opening of the fireplace chimney or chimney damper must be **29 sq. inches** based upon a minimum chimney height of at least 10 feet. Solid Fuels shall not be burned in a masonry or UL 127 factory built fire place where an **ALTERNATM** is installed.

LEAK TEST PROCEDURES

WARNING: DO NOT use an open flame to test leaks!

Create a mixture of equal parts soap and water. Apply to all the joints of the pipe fittings from the gas supply to the burner. Turn on the gas supply valve for no longer than 3-5 seconds. If bubbles appear in the soap solution applied to the joints, there is a leak. Turn off the gas supply valve and tighten those fittings. Repeat the procedure until no more bubbles appear. Test all joints. **NOTE:** Always perform a leak test any time the appliance has been moved or disconnected from the gas supply line.

WARNING!

VENTED INSTALLATIONS

WARNING!

THE CHIMNEY DAMPER MUST BE WIDE OPEN AND FIXED IN A MANNER TO MAINTAIN A PERMANENT FREE OPENING AT ALL TIMES AS OUTLINED ABOVE. THE AREA OF THE FLUE MUST BE NOT LESS THAN 1/10 THE AREA OF THE FIREPLACE OPENING. THIS DECORATIVE GAS APPLIANCE MUST BE INSTALLED IN A FULLY VENTED METAL OR MASONRY FIREPLACE WITH A WORKING FLUE THAT IS SAFE FOR BURNING A WOOD FIRE. THE FLUE MUST BE FREE OF ANY OBSTRUCTIONS AND MUST EXHAUST ALL PRODUCTS OF COMBUSTION. DAMPER AND GLASS DOORS MUST BE FULLY OPEN BEFORE LIGHTING OR BURNING FOR PROPER VENTILATION AND TO PREVENT HEAT DAMAGE TO THE VALVE.

WARNING! CHECK FOR PROPER VENTING

A properly sized, unobstructed chimney will normally vent all products of combustion. Any odor or smoke detected inside the room is an indication that the flue is not functioning properly.

SHUT OFF THE BURNER IMMEDIATELY! THE CAUSE OF THE VENTING PROBLEM MUST BE DISCOVERED AND CORRECTED BEFORE CONTINUED USE.

Continued use with improper venting may cause damage to your fireplace, room furnishings and could cause serious illness. **IF IMPROPER VENTING IS SUSPECTED, IMMEDIATELY HAVE THE APPLIANCE AND CHIMNEY FLUE SERVICED.**

In the Commonwealth of Massachusetts:

- Installation must be performed by a licensed plumber or gas fitter.
- The chimney flue damper, when used with gas logs, will be welded open or completely removed.
- A CO detector shall be installed in the room where the appliance is installed.

INSTALLATION AND GAS SUPPLY CONNECTION (ALL MODELS)

WARNING:

Be certain that combustible flooring material (i.e.; carpet, tile etc.) is not too close to this gas appliance. If this appliance is at floor level or less than 6" above the floor, there must be at least 12" of noncombustible material between the base of the fireplace and any combustible flooring.

STEP TWO: BURNER INSTALLATION AND GAS SUPPLY CONNECTION

1. Insure that the Gas Supply to the Fireplace is turned off and verify correct gas type and proper gas pressures.
2. Seal threads of gas supply with pipe compound, then thread $1/2"$ FIP x $3/8"$ Flared Elbow (Figures 3 and 4A) onto the Gas Supply Pipe (Figures 3 and 4B) and wrench tighten.
3. Place The ALTERNA™ inside firebox or approved enclosure centered from left to right and as far to the rear of the firebox as possible. Thread one end of the supplied Flex Connector (Figures 3 and 4C below) to the Gas Input (Figure 4D), then connect the other end to the $1/2"$ FIP x $3/8"$ Flared Elbow (Figures 3 and 4A) attached to the Gas Supply Pipe. If Flex Connector is bent into too small a radius it may kink or break causing air flow noise and/or gas leaks.

FIGURE 3

Top View

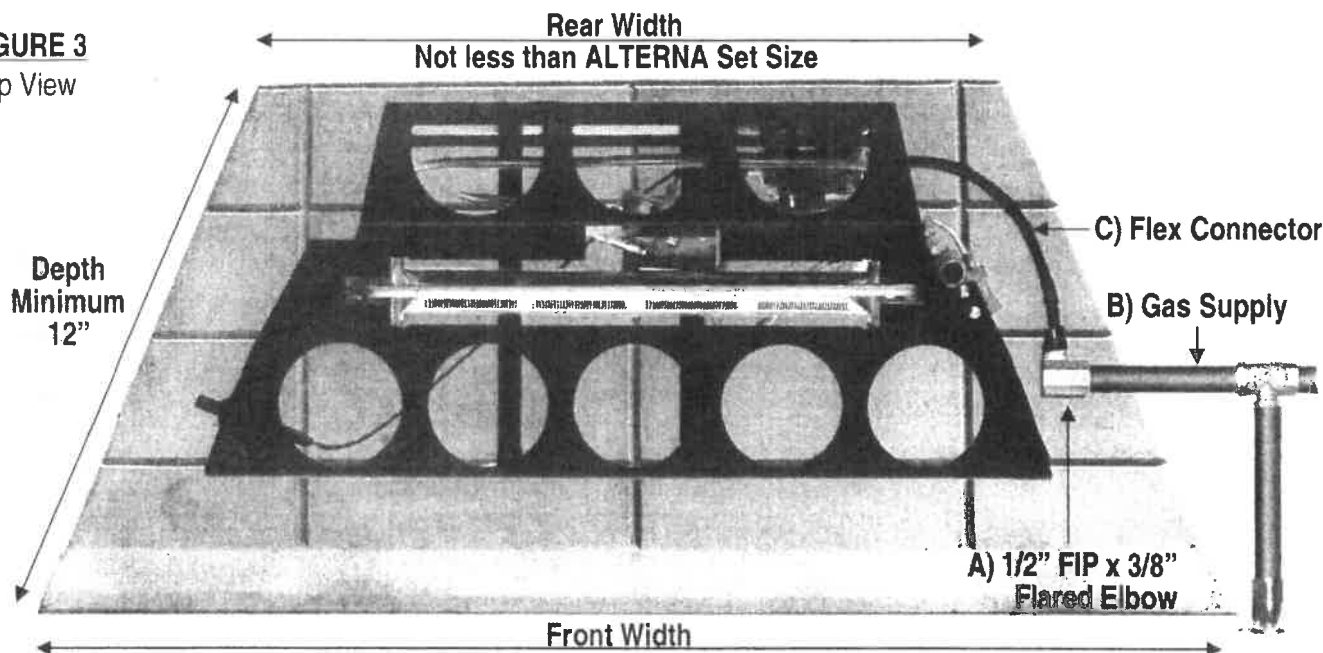

The minimum dimensions of the fireplace in which this ALTERNA™ is to be installed, allowing adequate clearances for accessibility for purposes of servicing and proper installation are as follows; Minimum opening height 16 inches, Firebox depth, 11 inches (Figure 3 above). Front width shall be a minimum of 6" greater than front width of ALTERNA.

FIGURE 4

Right Side View

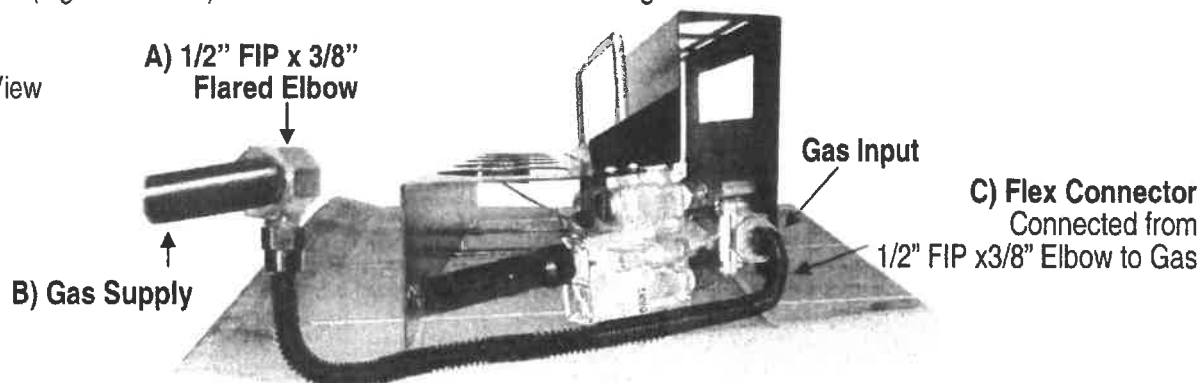

MINIMUM AND MAXIMUM INLET GAS SUPPLY PRESSURE

The minimum inlet gas supply pressure shall be 5 inches of water column on Natural Gas and 11 inches of water column on Propane. The maximum inlet gas supply pressure shall be 7 inches of water column on Natural Gas and 14 inches of water column on Propane. The appliance and its main gas valve must be disconnected from the gas supply piping system during any pressure testing of that system at test pressures in excess of $1/2$ psi (3.5 kPa) and isolated from the gas supply piping system during any pressure testing at equal to or less than $1/2$ psi (3.5 kPa).

FIREBALL PLACEMENT (AFB30)

WARNING: Failure to position the parts in accordance with these diagrams or failure to use only parts specifically approved with this heater may result in property damage or personal injury.

STEP ONE: Begin by placing the first row of 6 Full FireBalls (FB4) one by one into each locator hole on burner with flat, rough side facing down (Figure 5A and B). (About one half inch of the tapered end will fit into the locator hole.)

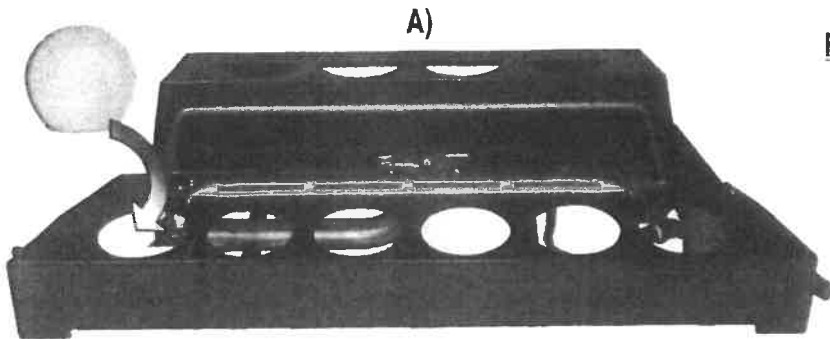
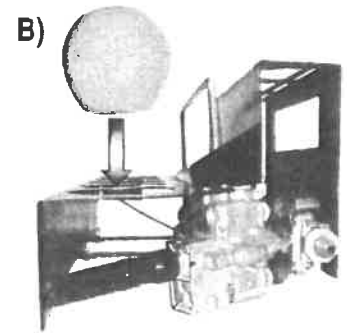

FIGURE 5



STEP TWO: Next place the second row of 5 Full FireBalls on top of the first row with flat side resting against Flame Rod. (Figure 6A and B)

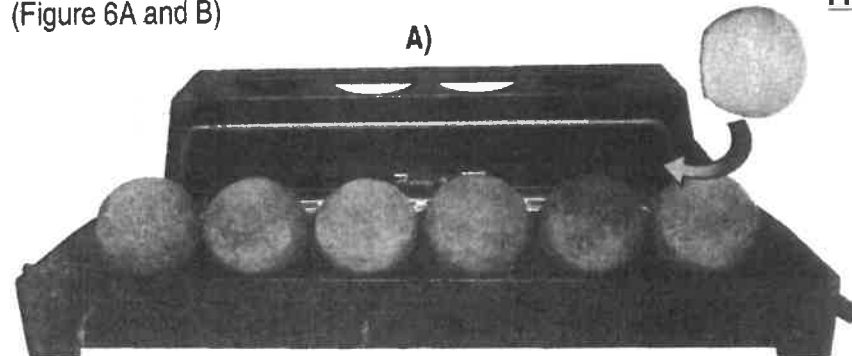
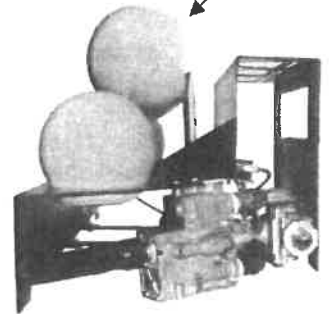

FIGURE 6

B) Second row with flat side resting against Flame Rod.



STEP THREE: Now place the third row of 4 Half FireBalls (FB-4H) into the crescent shaped locator holes. (Figure 7)

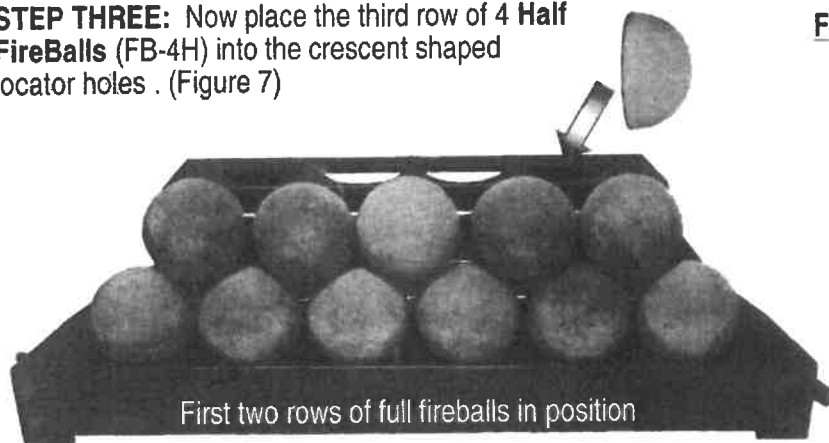

FIGURE 7

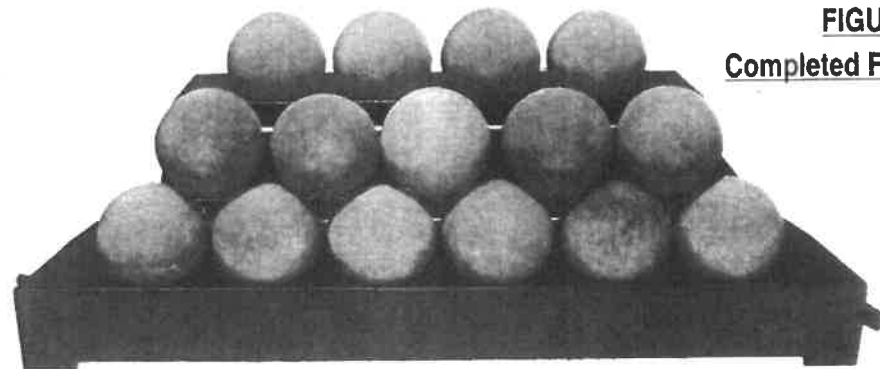
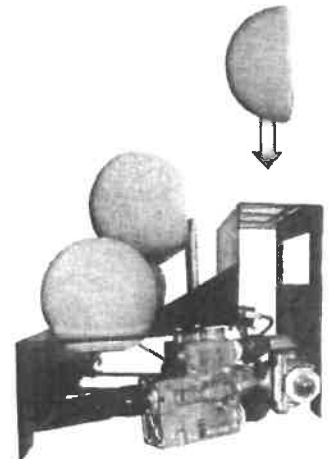
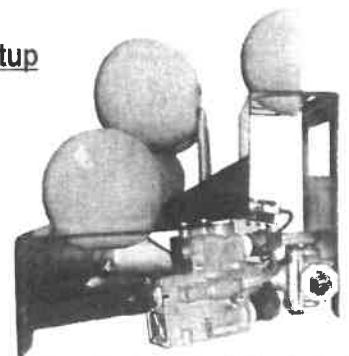

FIGURE 8
Completed Fireball Setup



FIREBALL PLACEMENT AFB20 AND AFB24

Fireball placement for the AFB20 and AFB24 is similar to that of the AFB30, but with fewer FireBalls. See previous page for placement details.

FIGURE 9
AFB20

Top Row = FB-4H x 2

Middle Row = FB-4 x 3

Bottom Row = FB-4 x 4

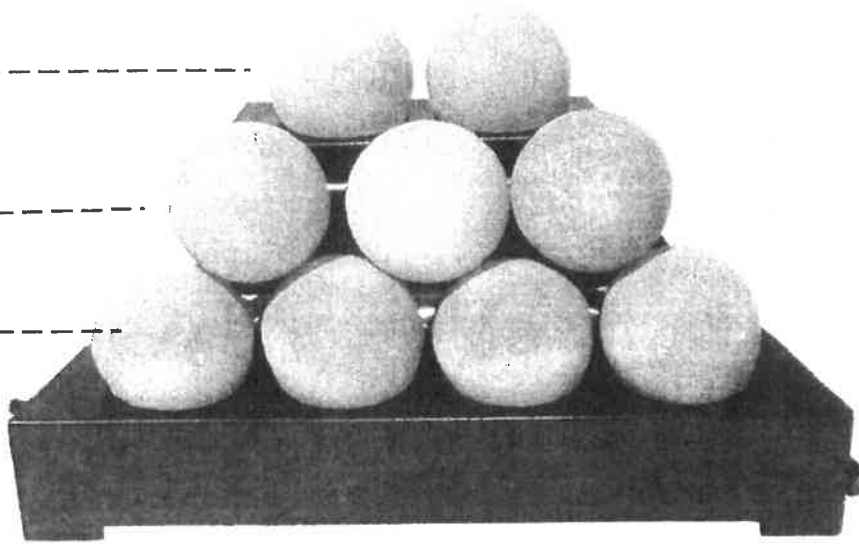
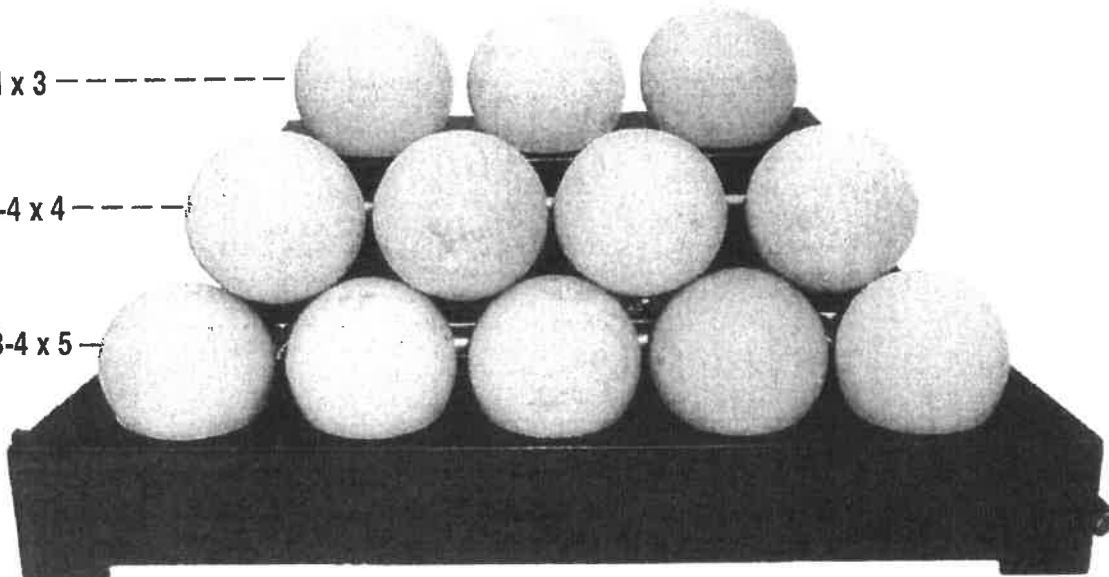

FIGURE 10
AFB24

Top Row = FB-4H x 3

Middle Row = FB-4 x 4

Bottom Row = FB-4 x 5



WARNING: Failure to position the parts in accordance with these diagrams or failure to use only parts specifically approved with this heater may result in property damage or personal injury.

AFG30 MEDIUM PLACEMENT (FIRESHAPES)

STEP ONE: Place bottom row of FireShapes into the locator holes on the ALTERNA in the order shown below beginning from left to right. The four sided Pyramid (**PY4-44**) will fit into the first hole on the left side at a slight angle leaning forward and to the right (Figures 12 below, and 13A, next page). The full Fireball (**FB-4**) will fit into the next hole with the tapered end facing down (Figure 12). Next, place the Cube FireShape (**CU-44**) into the third locator hole with the rear right corner resting on the edge of the burner allowing it to lean slightly forward into the locator hole (Figures 12 and 15A). Now, place a flat topped Cone FireShape (**CO-63**) into the next hole resting on it's side (Figures 12 and 15). A Cylinder (**CY-63**) will fit into the 2nd hole from the right at a slight angle resting against the Flame Rod (Figures 14B and 15B). Last, place the (**CO-55**) Cone into the first locator hole on the right leaning slightly forward into locator hole (Figure 14D).

STEP TWO: Begin the second row by placing the second flat topped Cone (**CO-63**) directly over the top left locator hole (Figure 13B). Next, place the 2nd Cylinder (**CY-63**) into the 2nd hole from the left lying on it's side with rough end facing rear wall (Figures 12 and 15). The Half FireBall (**FB-4H**) will fit into the next locator hole (also with flat, rough side facing rear wall) (Figure 15C). Last, place the 3 sided Pyramid (**PY3-44**) into the remaining hole leaning slightly forward (Figure 14C).

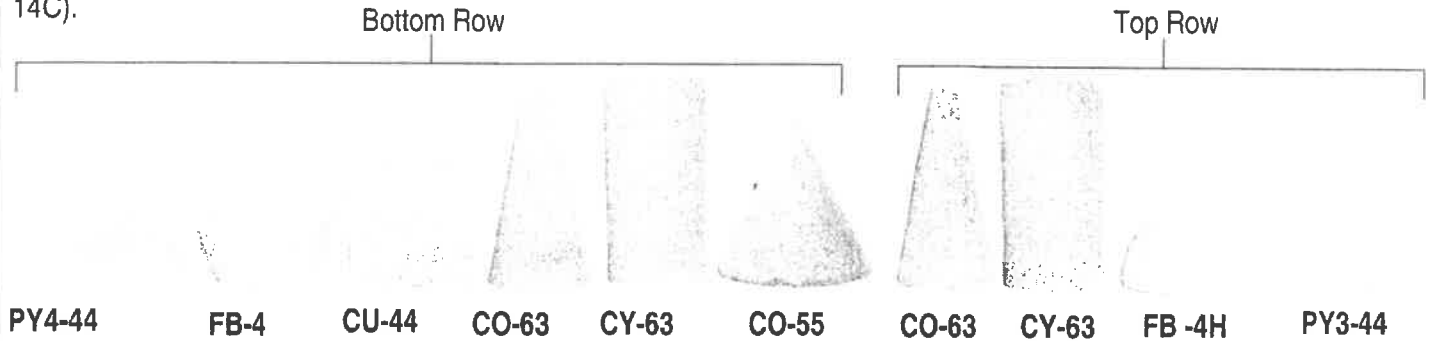

FIGURE 11

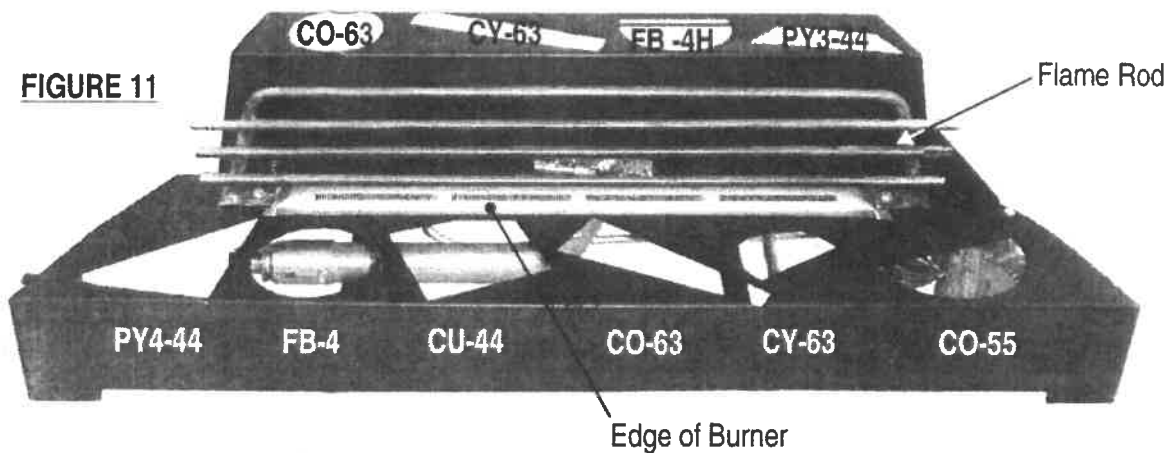
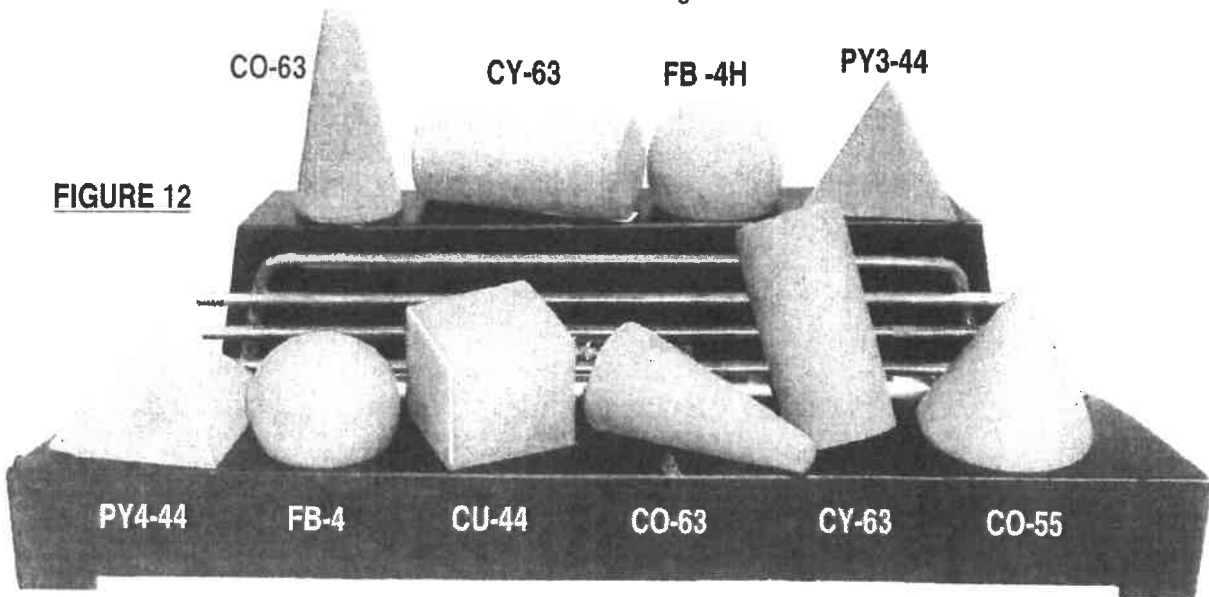

FIGURE 12



FIRESHAPES PLACEMENT (AFG30 CONTINUED)

See Figures 13, 14 and 15 below for a further explanation of the ALTERNA 24 FireShapes placement.

FIGURE 13
Left Side View

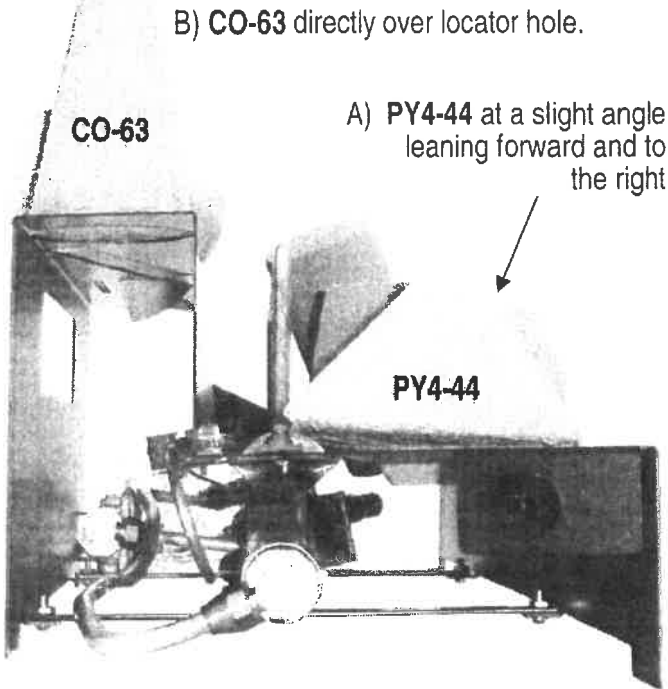

FIGURE 14
Right Side View

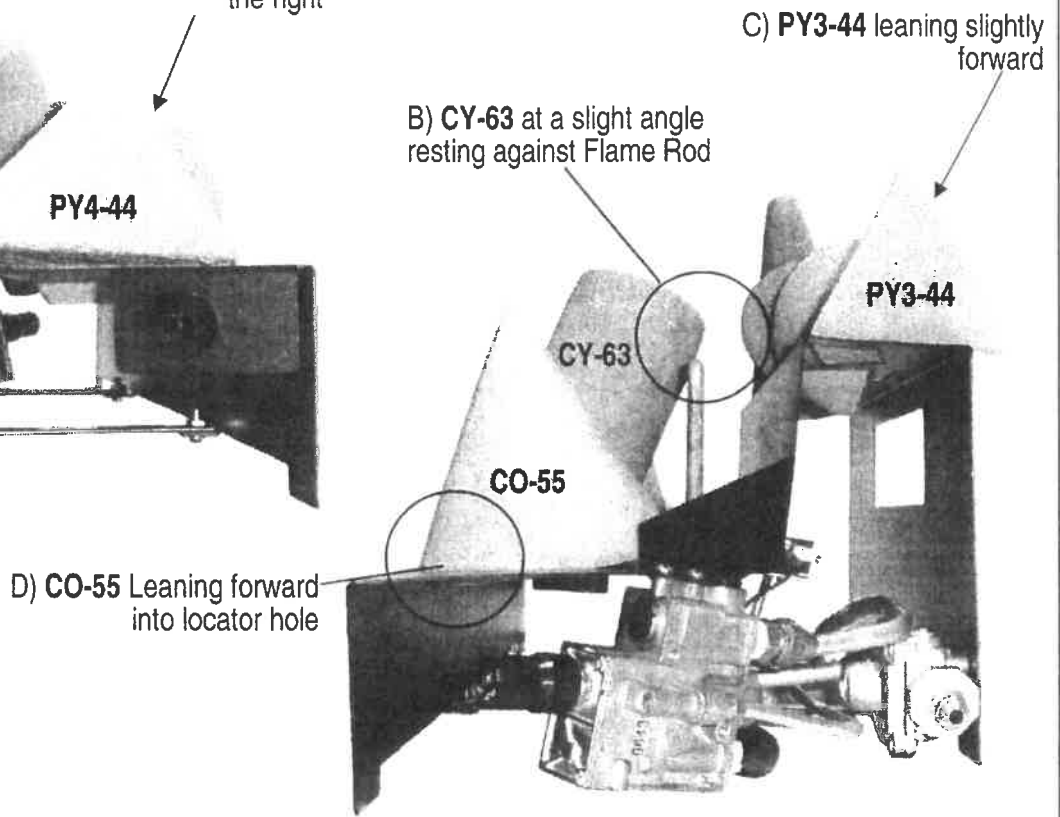
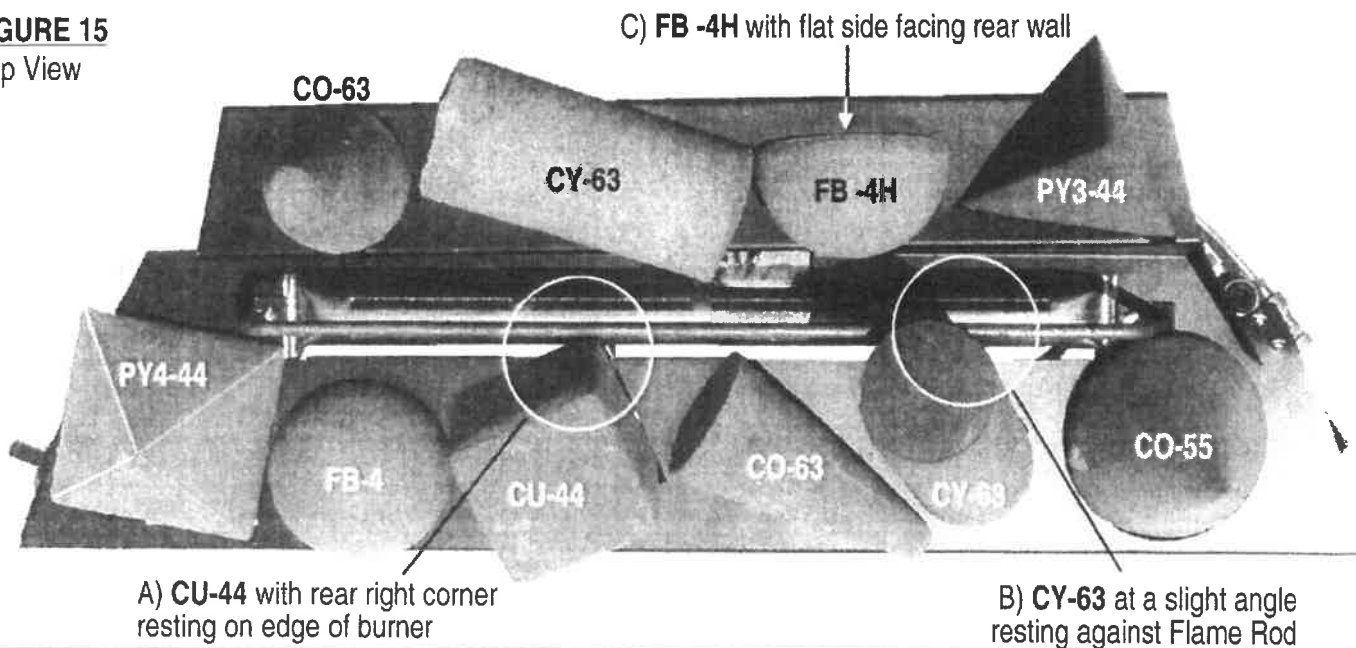

FIGURE 15
Top View



FIRESHAPES PLACEMENT (AFG24)

WARNING: Failure to position the parts in accordance with these diagrams or failure to use only parts specifically approved with this heater may result in property damage or personal injury.

Placement of FireShapes for the AFG24 is similar to that of the AFG30, but with fewer objects. Consult AFG30 placement on pages 11 and 12 for detailed step by step instructions if needed.

FIGURE 16
Front View

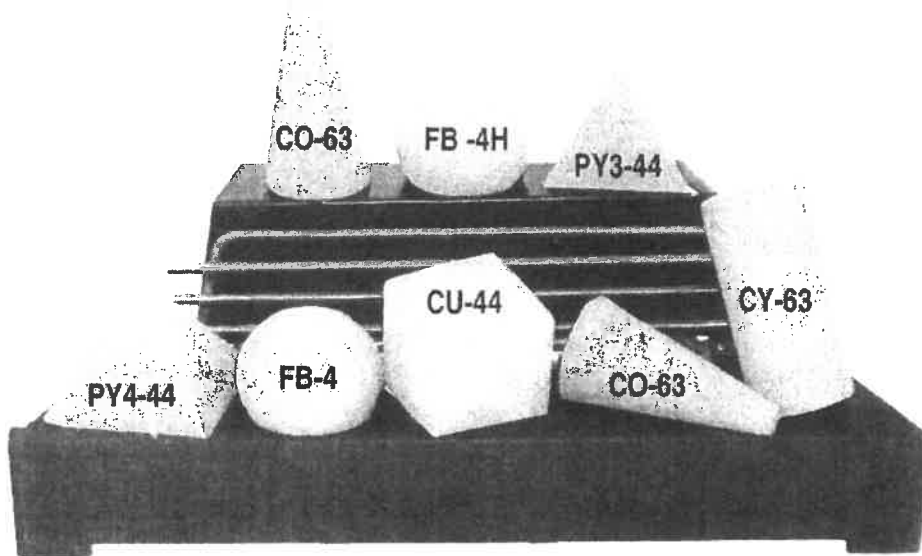
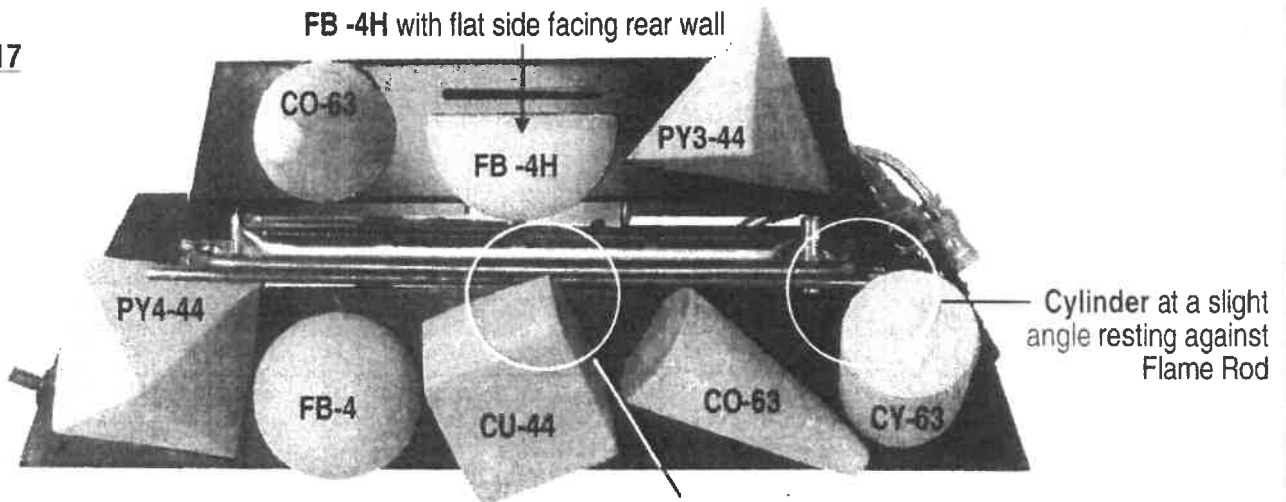

FIGURE 17
Top View



CU-44 with right rear corner resting on edge of burner

FIGURE 18
Right Side View

CY-63 at a slight angle resting against Flame Rod

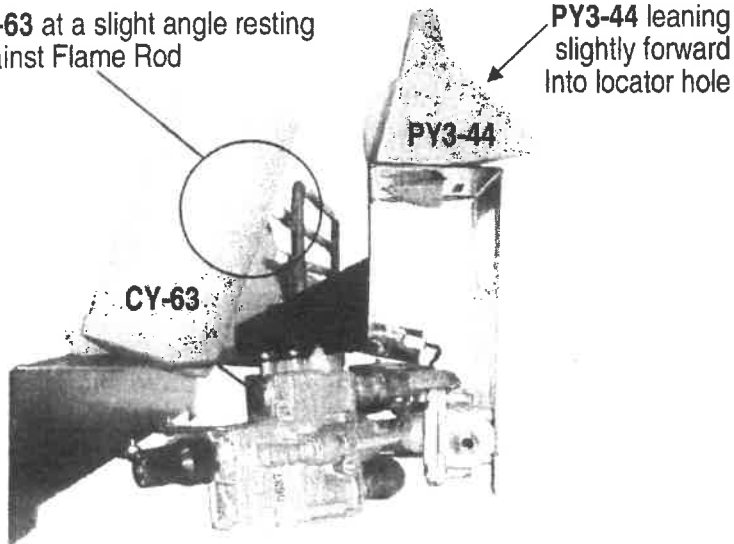
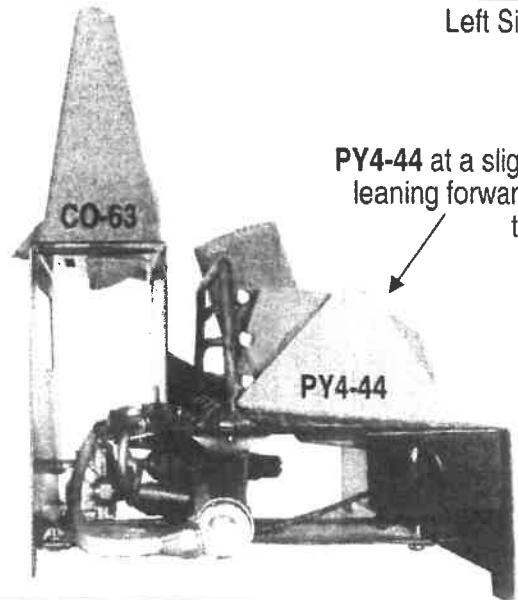

FIGURE 19
Left Side View

PY4-44 at a slight angle leaning forward and to the right.



FIRESHAPES PLACEMENT (AFG20)

Placement of FireShapes for the AFG20 is similar to that of the AFG30, but with fewer shapes. Consult AFG30 placement on pages 11 and 12 for detailed step by step instructions, if needed.

FIGURE 20
Front View

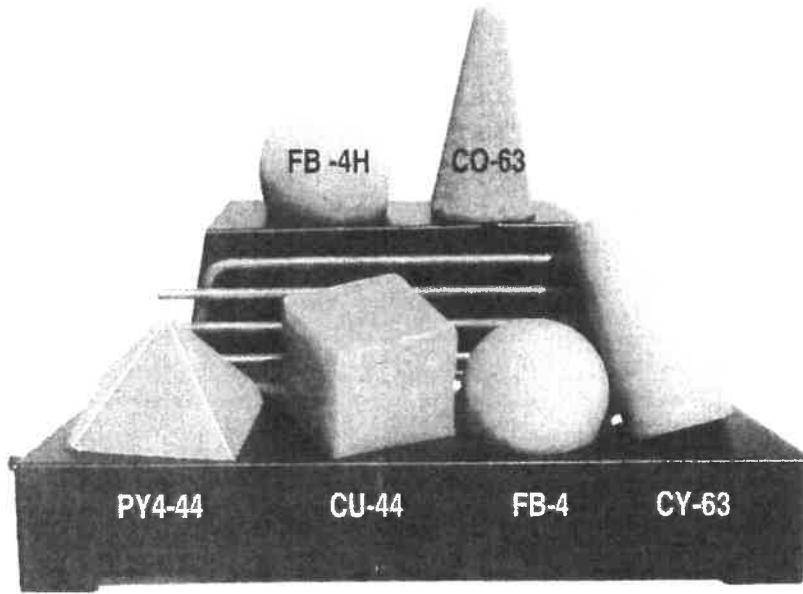

FIGURE 21
Top View

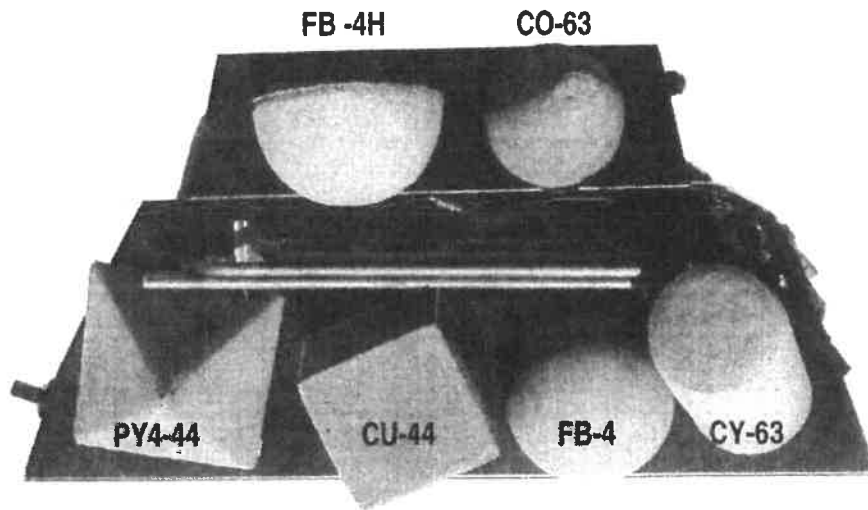

FIGURE 22
Right Side View

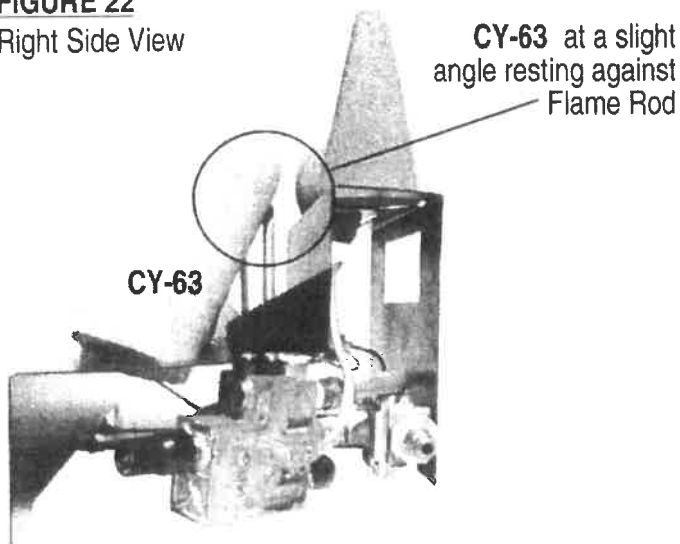
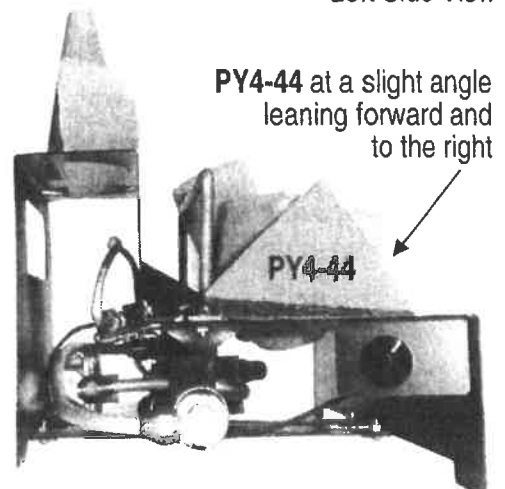

FIGURE 23
Left Side View



FIRESTONES PLACEMENT (AFS30)

WARNING: Failure to position the parts in accordance with these diagrams or failure to use only parts specifically approved with this heater may result in property damage or personal injury.

When placing FireStones in or on locator holes consider the shape of each FireStone and its corresponding locator hole. The lower portion (approximately 1/4" to 1/2") of each FireStone on the top row will fit *into* the locator holes (see Figure 22). FireStones on the bottom row are to be placed *over* each locator hole (Figures 22 and 23). Place each FireStone on the 2nd or middle row on top of those on the first row with back side of each resting against Flame Rod (see page 17, Figure 25)

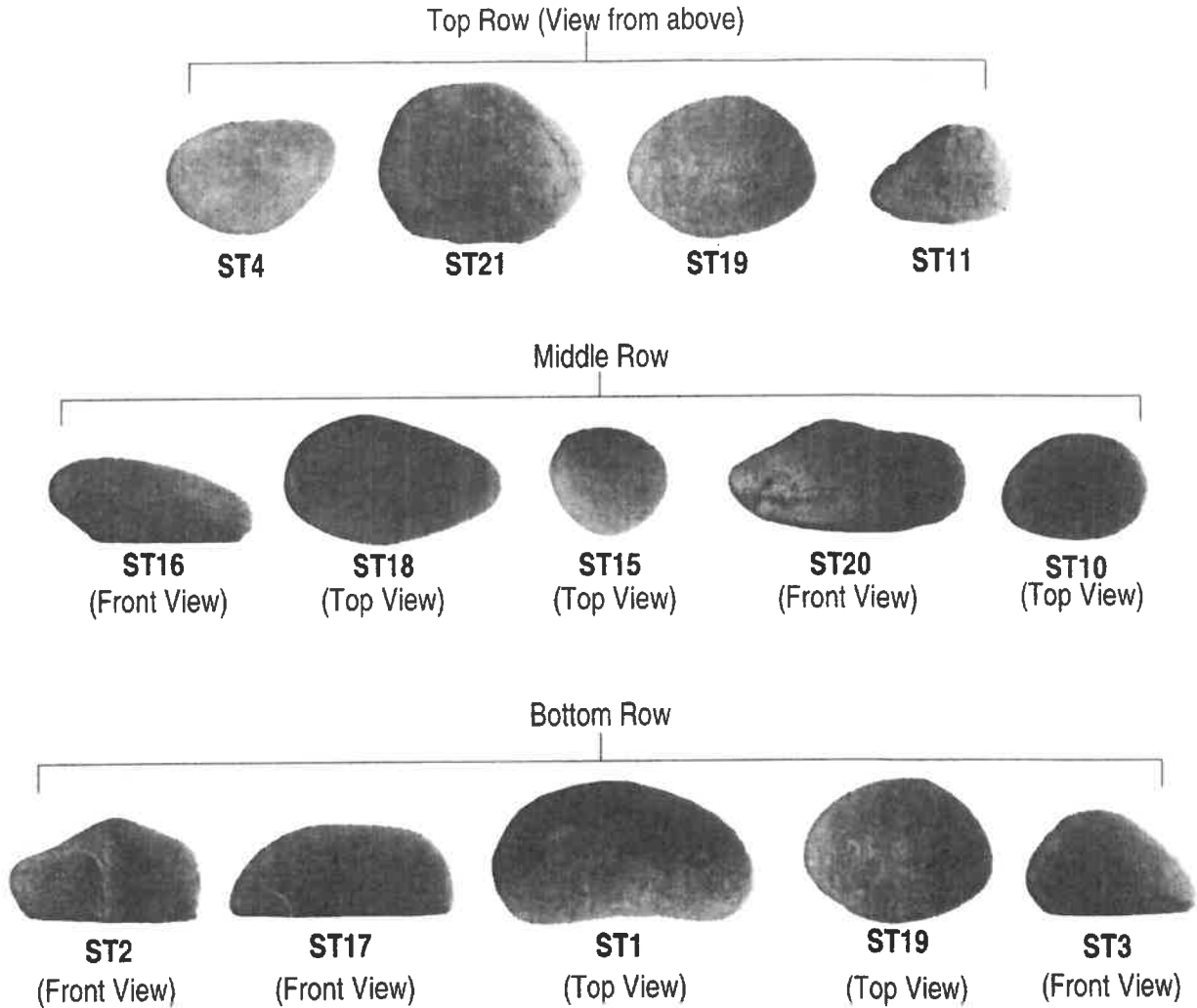
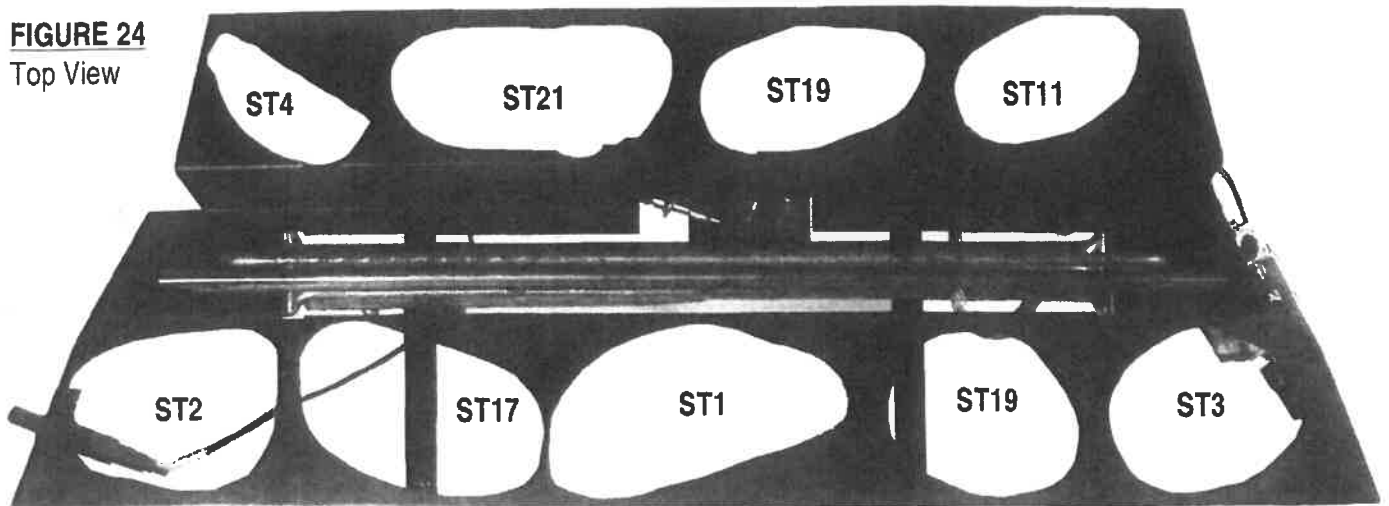

FIGURE 24
Top View



FIRESTONES PLACEMENT (AFS30 CONTINUED)

WARNING: Failure to position the parts in accordance with these diagrams or failure to use only parts specifically approved with this heater may result in property damage or personal injury.

FIGURE 25

Front View

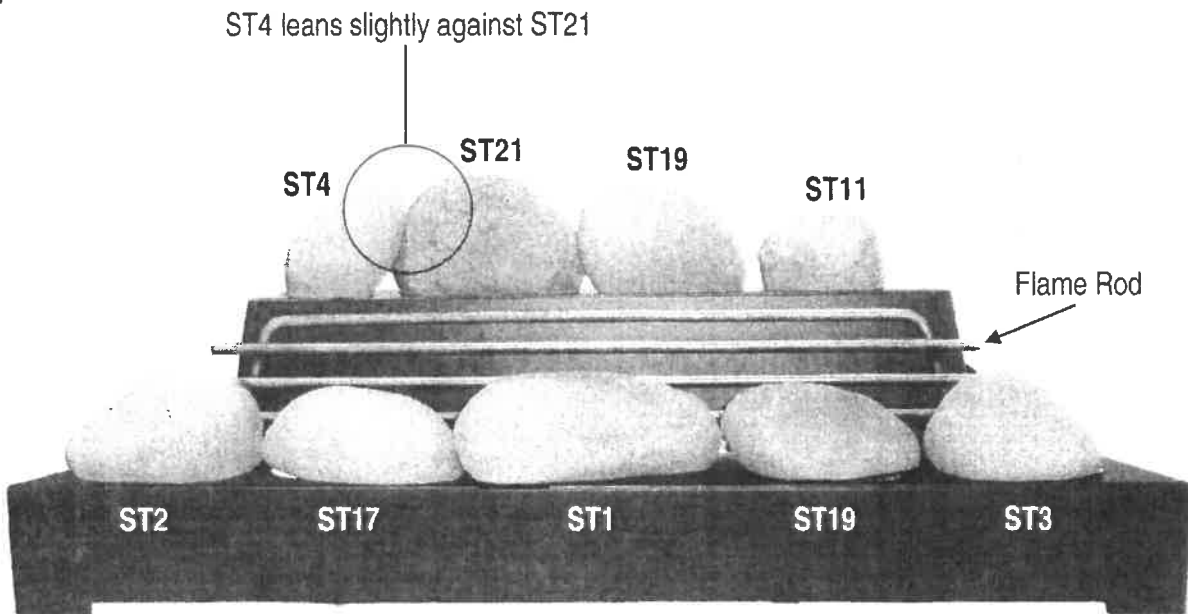
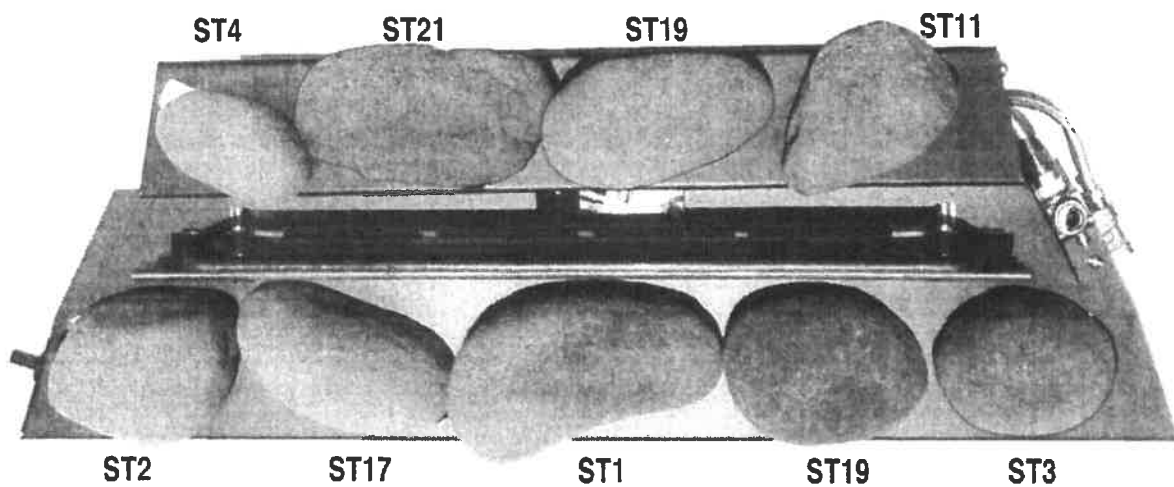

FIGURE 26

Top View



FIRESTONES PLACEMENT (AFS30 CONTINUED)

WARNING: Failure to position the parts in accordance with these diagrams or failure to use only parts specifically approved with this heater may result in property damage or personal injury.

FIGURE 27
Front View

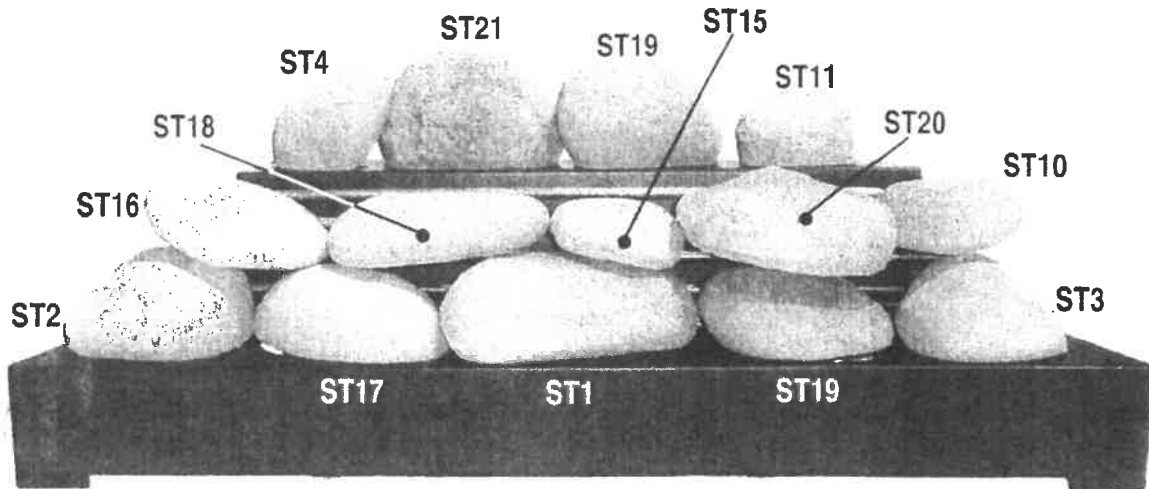

The AFS30 should look like the illustration above when completed.

FIGURE 28
Top View

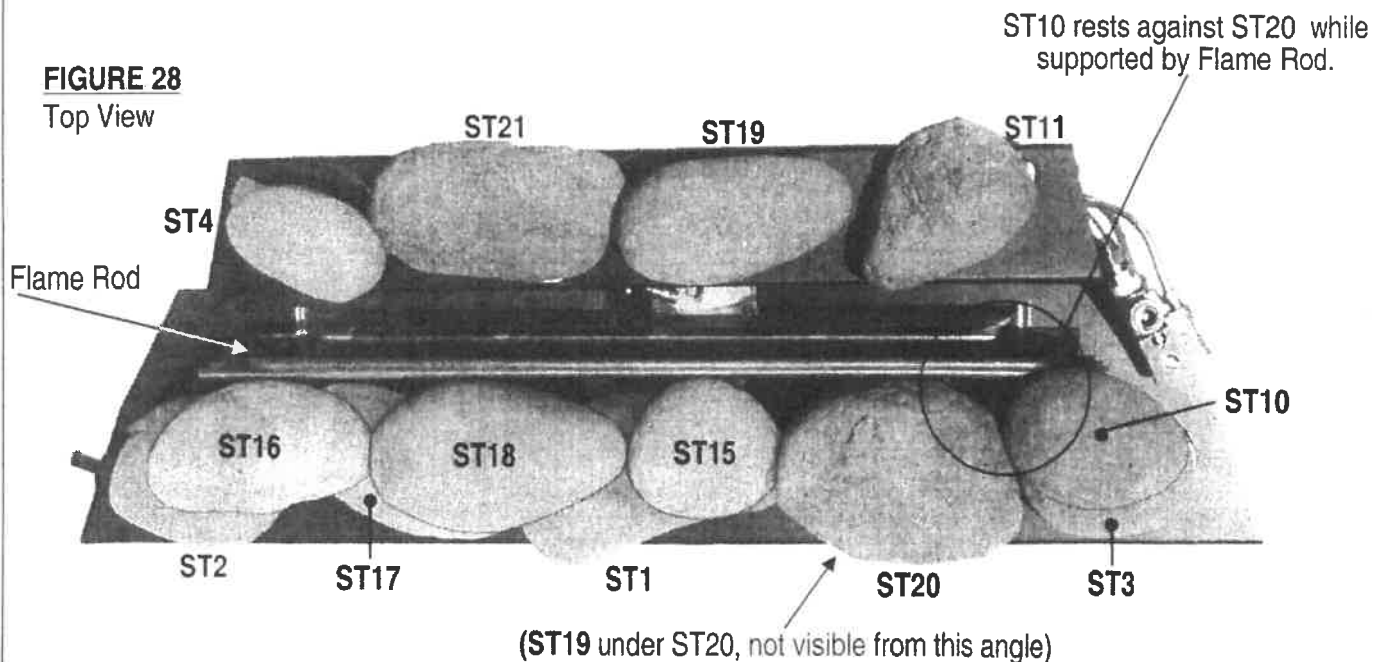

2nd Row of FireStones (ST16, ST18, ST15, ST20 and ST10) shown above resting against Flame Rod.

FIRESTONES PLACEMENT (AFS20 AND 24)

WARNING: Failure to position the parts in accordance with these diagrams or failure to use only parts specifically approved with this heater may result in property damage or personal injury.

Placement of FireStones for the AFS20 and AFS24 is similar to that of the AFS30 with the exception of a few removed stones on the right side of the appliance.. The AFS24 includes all eight FireStones on the right with the addition of the three FireStones on the left.

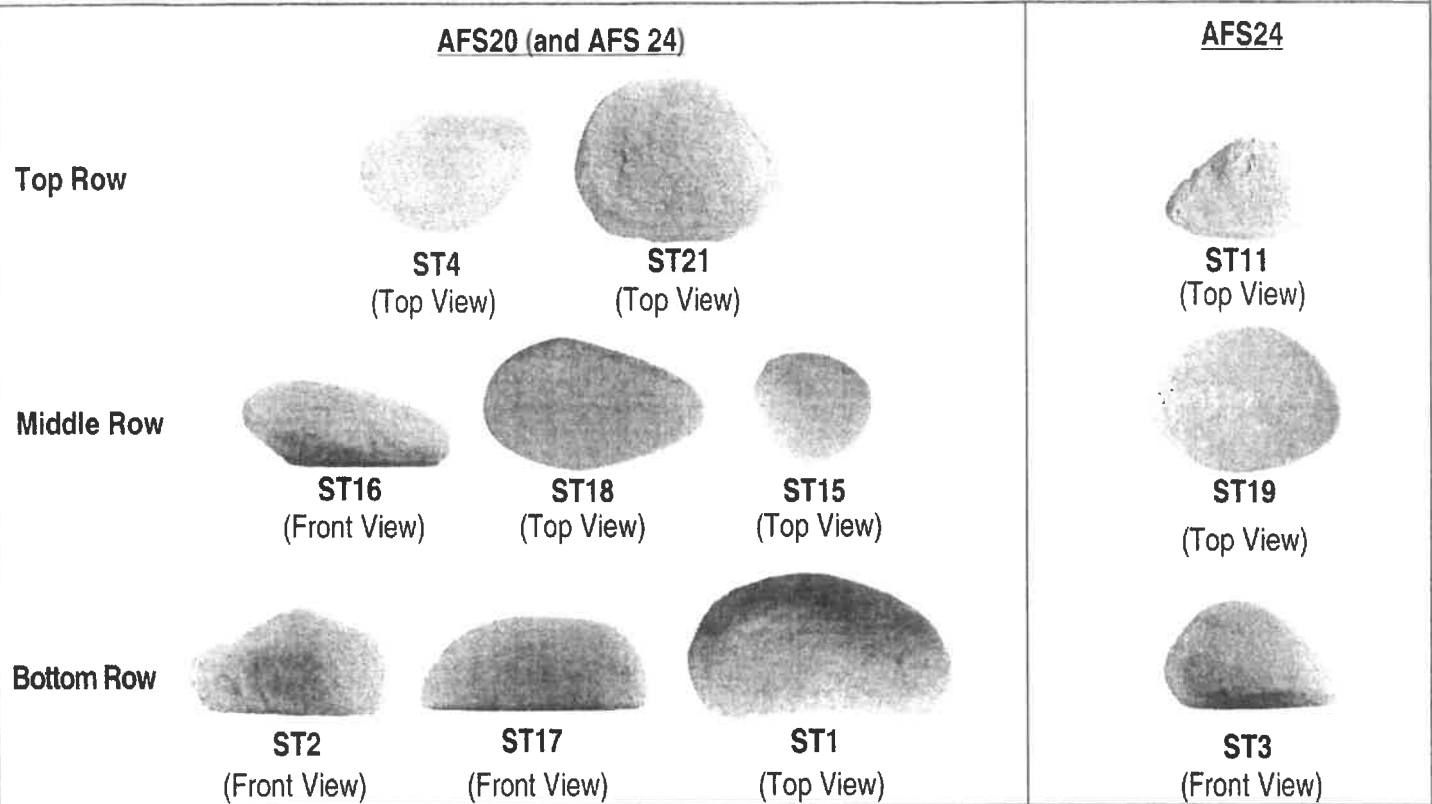

FIGURE 29
AFS20

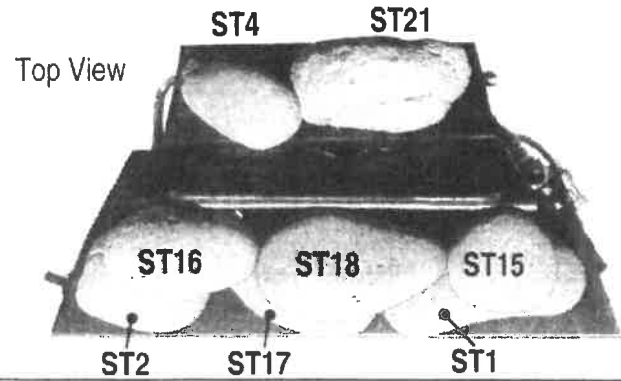
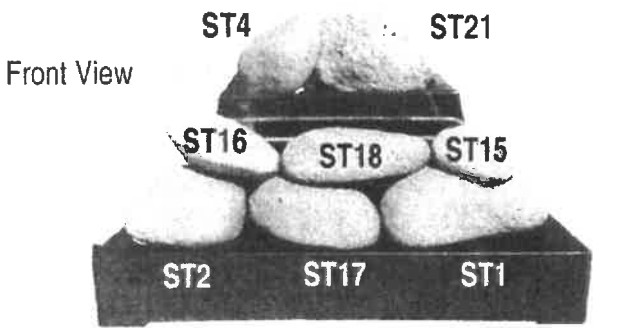
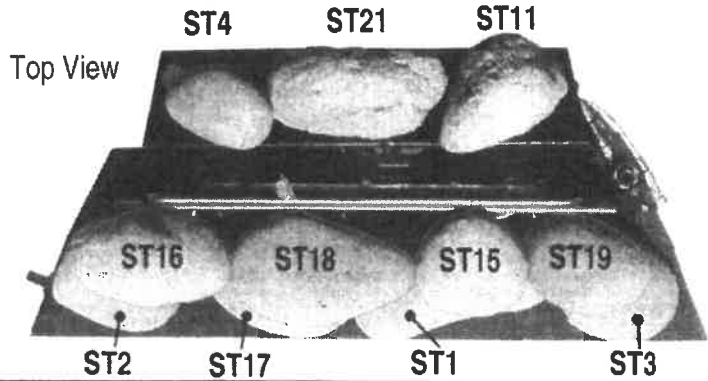
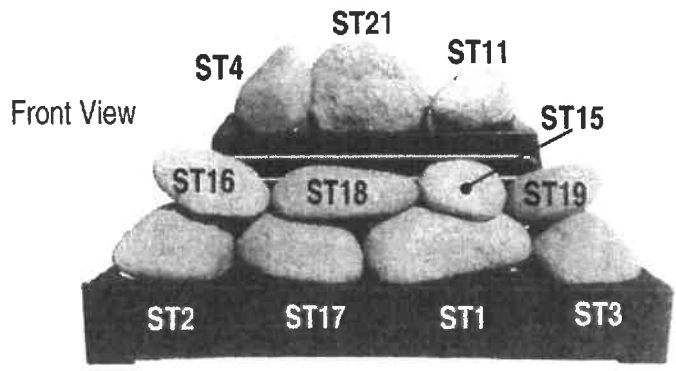

FIGURE 30
AFS24



VENTED MODELS IMPORTANT!

CHIMNEY DAMPER MUST BE WIDE OPEN! THE FLUE MUST VENT ALL PRODUCTS OF COMBUSTION. DAMPER AND GLASS DOORS MUST BE FULLY OPEN BEFORE LIGHTING OR BURNING FOR PROPER VENTILATION AND TO PREVENT HEAT DAMAGE TO VALVE.

ALL APPLICATIONS - IMPORTANT INFORMATION

- This appliance is equipped with a Safety Pilot System designed to shut itself off if enough fresh air is not available. Additional ventilation may be obtained by opening a window or a door to another room.
- Matches, paper, garbage, or any other foreign material **MUST NOT** be thrown on top of burner medium or into the flames.
- Avoid contact with the burner, burner medium, grate or any other part which may be hot.
- Always ensure that the fireplace screen is closed when the appliance is operating.

REMOTE RECEIVER PLACEMENT (“-SE AND “-RE” MODELS)

The Remote Receiver (-RE and -SE models) (Figure 31) can be adversely affected by heat and must be placed as far forward and to the side of your **ALTERNA™** as possible (Figure 31A). Our optional **Ceramic Remote House** accessory (Figure 31B, Item “RH3”), offers heat protection for the Remote Receiver while being pleasing to the eye (remove plastic heat shield form receiver before placing inside remote house). When connecting receiver to Motor drive (“-RE” models) or Solenoid (“SE models) be sure to match red and black connectors, red to red and black to black).

Volcanic Ash Placement: (purchase separately)

Volcanic Ash should only be used on the firebox floor as floor dressing (Figure 31C below). **DO NOT** place **Volcanic Ash** (or any other material) on top of the burner!!!

FIGURE 31

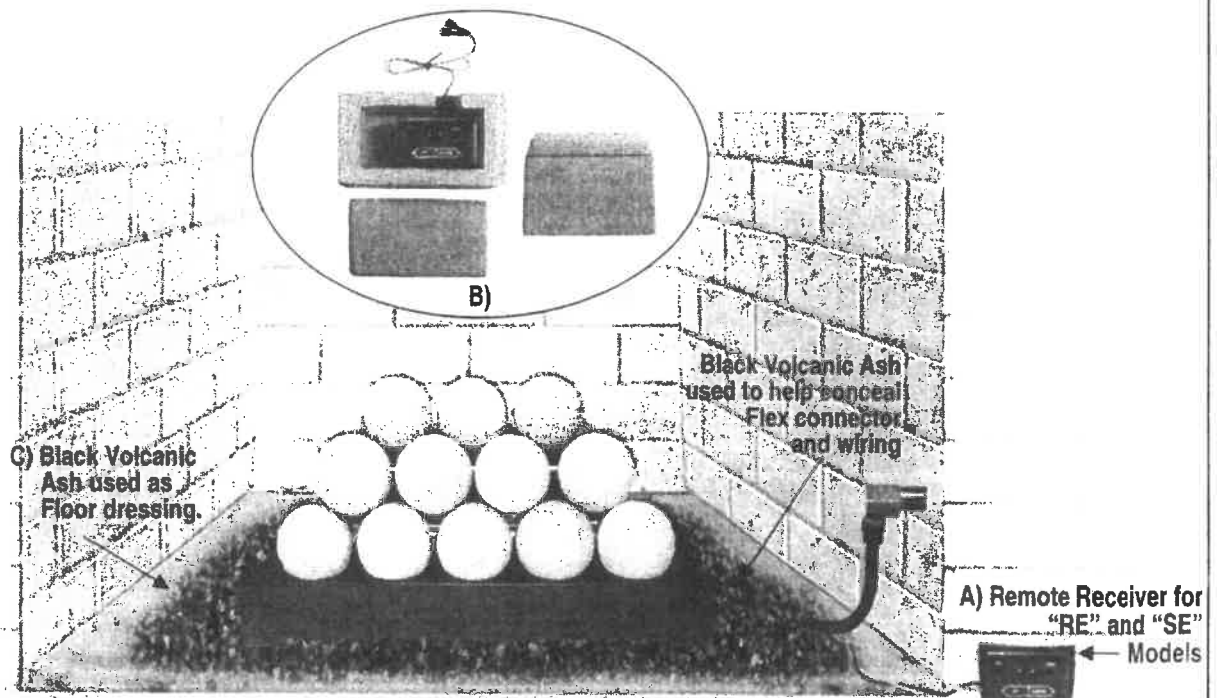

NOTE: Any beeping or unexpected shutdown may be the over-temperature safety feature in the receiver. If this happens, move the receiver into a cooler area, and/or use the RH3 remote house.

LIGHTING AND OPERATION (ALL MODELS)

STEP ONE: PILOT LIGHTING (ALL MODELS)

1. Slightly push in the "EASY" Safety Valve Knob, located behind the ALTERNA™ face plate on the right side (Figure 32A), and turn clockwise to "OFF".
 2. Before lighting, wait at least five minutes to allow gas which may have accumulated around burner to escape, then slightly push in the "EASY" Safety Valve Knob and turn to "PILOT/OFF".
 3. Depress Valve Knob until air dissipates and gas flows to pilot (located at center of ALTERNA™). Press the **Piezo Igniter Button** (left side of ALTERNA™) (Figure 33) to light the pilot, and continue to hold Valve Knob in until pilot remains lighted after knob is released. The pilot flame should be steady and soft blue surrounding 1/8 inch of the thermocouple tip and extending approximately 1 inch beyond the pilot tube as shown in Figures 34 A and B below.
- NOTE:** If pilot flame adjustment is necessary, use a narrow long stem flathead screwdriver to turn **Pilot Adjustment Screw** clockwise for less flame, counterclockwise for more (Figure 32B). If after pilot adjustment the burner begins to shutdown, re-adjust for a longer pilot flame.
4. Slowly turn Valve Knob to "ON" to light burner. (If burner fails to light or if pilot goes out, repeat steps 1 through 4.)
 5. Adjust the burner flame height by turning the "EASY" Safety Valve Knob clockwise to lower and counter-clockwise to raise up to full on (Figure 32).
 6. For complete shutdown, push "EASY" Safety Valve in and turn to "OFF".

FIGURE 32

VALVE PLUG ("ME" MANUAL "EASY" CONTROL) SHOWN, ALSO LOCATION FOR:

- ON/OFF SOLENOID ("SE" REMOTE READY MODELS) OR
- DC MOTOR DRIVE ("RE" VARIABLE FLAME HEIGHT MODELS) BOTH SHOWN ON FOLLOWING PAGE.

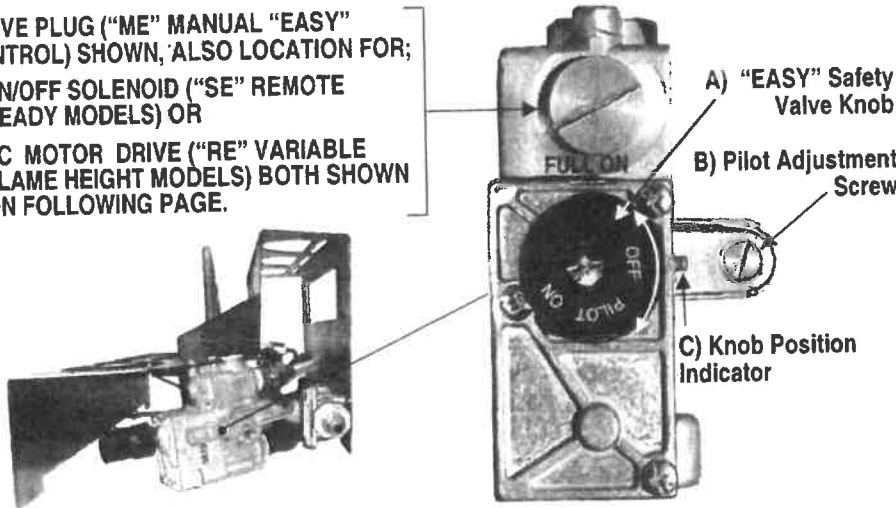
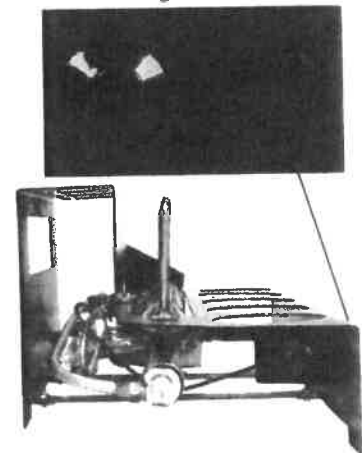

FIGURE 33

Piezo Igniter Button



NOTE: The "EASY" Safety Valve has complete control of gas to the pilot and burner. It cannot be turned to "OFF" without first depressing knob to the "PILOT" position and then rotating clockwise to "OFF". During the heating season leave valve knob in "PILOT" position for convenience. Otherwise, turn to "OFF" position for any prolonged non-use. Periodically check the pilot and burner flame for proper appearance (see page 23 "Customer Responsibilities and Maintenance").

FIGURE 34

Models mfg'd from 6/99 thru 01/08

A) Propane Pilot Assembly (ODS-OP-P)

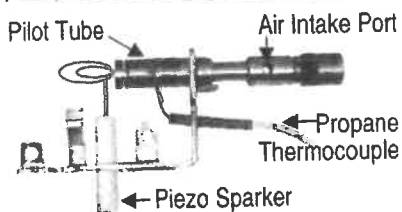

A) Propane Pilot Assembly (ODS-ROP-P)

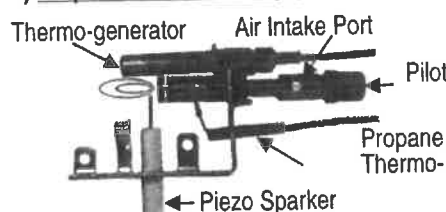

B) Natural Gas Pilot Assembly (ODS-OP-N)

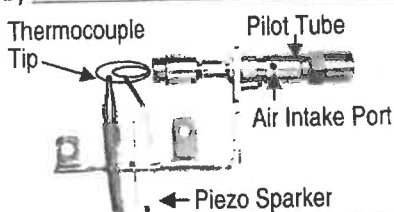

B) Natural Gas Pilot Assembly (ODS-ROP-N)

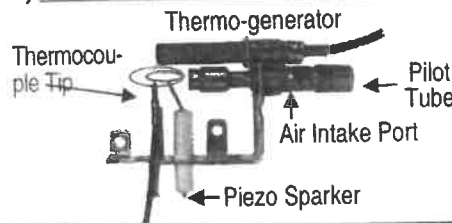

Models mfg'd from 01/08 to present

A) Propane Pilot Assembly (ODS-CN-P)

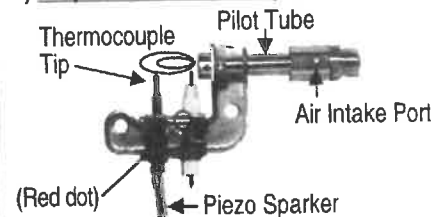

B) Natural Gas Pilot Assembly (ODS-CN-N)

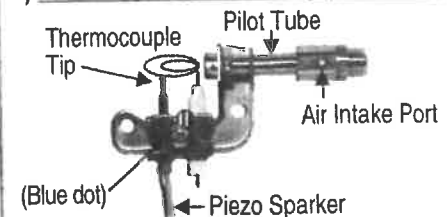

IMPORTANT!

KEEP BURNER AND CONTROL COMPARTMENT CLEAN

IMPORTANT!

STEP TWO: PILOT ADJUSTMENT (ALL MODELS)

PILOT FLAME ADJUSTMENT: If adjustment is necessary, use a narrow long stem screw driver to turn pilot adjustment screw. To adjust turn clockwise for less pilot flame, counterclockwise for more pilot flame.

IMPORTANT SERVICE TIP! Obstructed Pilot Air Intake Ports result in an improper gas/air mixture and a weak pilot flame. **Weak pilot flame is the NUMBER 1 SERVICE ISSUE REGARDING NUISANCE SHUT-OFF.** Using canned compressed air, a pipe cleaner or an artist's brush, clean out the opposing air intake ports located at the base of the pilot (where the gas supply line attaches to the pilot) (See page 13, Figures 23A and B).

STEP THREE: BURNER OPERATION ("RE" VARIABLE FLAME HEIGHT MODELS AND "SE" REMOTE READY)

"RE" Models

1. Turn **Valve Knob** to "ON" position (Figure 35A) then slide switch on the **Receiver** (Figure 36) to "REMOTE" position.
2. Depress the "ON/HI" button on the **TRANSMITTER** (Figure 37) until a click is heard. The burner will then light to "Full on".

NOTE: Reducing the burner flame can be achieved by pressing the "LO" button one beep at a time to the desired flame height. Pressing the "ON/HI" button one beep at a time will raise the burner flame). To verify the burner is completely off, press the "OFF" button once.

FIGURE 35

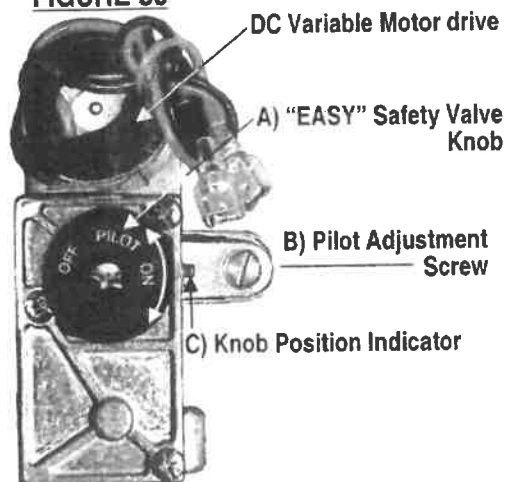
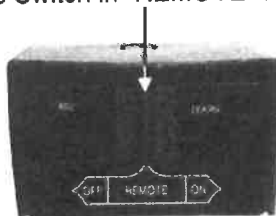

FIGURE 37
Transmitter



FIGURE 36

Slide Switch in "REMOTE" Position



"SE" Models

1. Turn **Valve Knob** to "ON" position (Figure 38A) then slide switch on the **Receiver** (Figure 36 above) to "REMOTE" position.
2. Consult Operating Instructions for Accessory Control (below), then adjust the burner flame height by turning the **Valve Knob** (Figure 38A) clockwise to lower and counter-clockwise to raise up to full on.

NOTE: During the heating season leave Valve Knob in "PILOT" position for convenience. Otherwise, turn to "OFF"

Accessory Controls

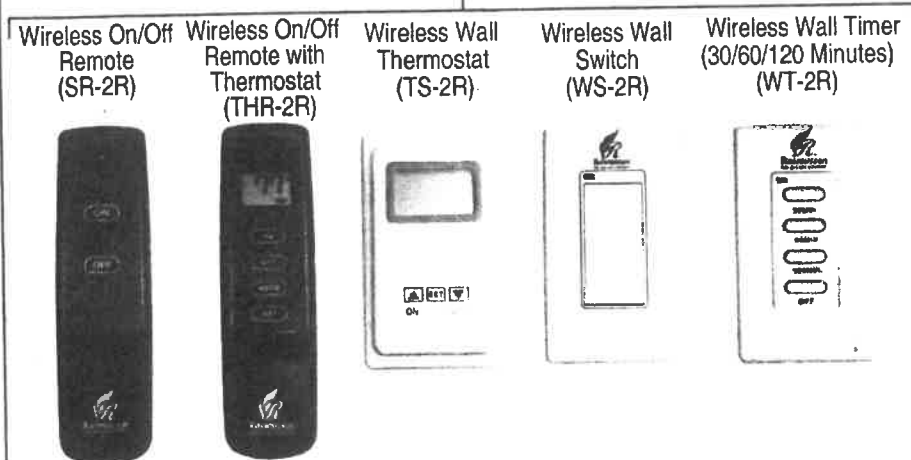
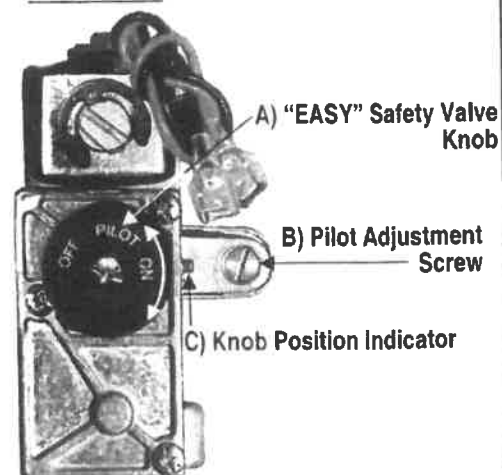

FIGURE 38



NOTE: The "EASY" Safety Valve has complete control of gas to the pilot and burner. It cannot be turned to "OFF" without first depressing knob to the "PILOT" position and then rotating clockwise to "OFF". During the heating season leave valve knob in "PILOT" position for convenience. Otherwise, turn to "OFF" position for any prolonged non-use.

NORMAL OPERATING CHARACTERISTICS

Each and every **ALTERNA™** that leaves the factory is quality checked to ensure compliance with our certification. This check includes an operational test to ensure both satisfactory combustion and proper operation. Each installation site for any vent free heater presents its own unique combustion environment. Specific factors such as weather tightness of the home, size of the room in which the heater is installed, central heating, ceiling fans, drafts, altitude, the size of the firebox, paint or soot inside the firebox, etc., all have an influence on the proper operation of any vent free gas heater.

A normally operating ALTERNA™ Gas Fire Set possess the following characteristics:

- Clean burning combustion, which, after normal break in, will produce no soot or smoke.
- A full bodied, lively flame. The flame will be blue at the base and a combination of blue and yellow at the body and tips.



- After initial break-in produce no odor other than the normal odors associated with the combustion of Natural or Propane gas and/or the environment in which the heater is operated.
- Will produce water vapor (increase indoor humidity) which may be beneficial during the dry heating season.

CUSTOMER RESPONSIBILITIES AND PERIODIC MAINTENANCE

- Keep the area around the **ALTERNA™** free and clear from debris. From time to time, visually check pilot and burner flames for proper appearance (see section above for burner; see Page 20 Fig. 34 for Pilot).
- Periodically examine and clean the venting system. Once every year, a qualified agency or certified chimney sweep should examine and clean the venting system of the solid fuel burning fireplace in which the **ALTERNA™** installed (if applicable).
- The air shutter and burner must be free of lint and dirt for optimum performance. Air shutters which have been closed or are obstructed with debris will not allow sufficient combustion air into the burner. Air shutters and burner ports (where flame comes out of the burner) should be periodically cleaned of debris. Use compressed air and/or a soft bristle brush to clean burner ports and air shutter area.. **Air shutters should not be altered from factory settings.**

WARNING: Failure to keep the burner primary air opening clean may result in sooting or property damage.

- Keep air intake holes of ODS Pilot (see Page 20 Figure 34) clear of lint. Over time lint will accumulate in these holes, and will eventually result in nuisance pilot outage or difficulty in lighting pilot. Clean these holes annually with compressed air or a pipe cleaner. **NOTE: Lint and dust in the Air Intake Holes is the #1 cause of nuisance pilot outage.**
- Do not operate in a dirty firebox or in a previously used firebox which has not had all soot completely removed or chimney flue cleaned. Previously used fireboxes must have flue and stack professionally cleaned by a chimney sweep. Additionally, firebox walls and damper must also be thoroughly cleaned of all burn residue and soot using a damp cloth, sponge or brush.
- Do not operate this set with any burner objects other than the **RASMUSSEN** FireBalls, FireShapes or FireStones specifically designed and approved for use with this Burner System.
- Do not use with blower inserts or heat exchangers.
- If used, glass doors must be wide open when burner is on.
- Do not remove Rating Plate/Warning Tags. These tags serve you and any future user as an integral safety and identification component of the **ALTERNA™** gas log heater. **Removing these tags voids the warranty.**
- **WARNING: Do not allow fans to blow directly into fireplace. Avoid any drafts that alter burner flame patterns.** Do not place blower inside area of firebox. Ceiling fans may create drafts that alter burner flame patterns. Sooting and improper burning may occur. Sooting can settle on surfaces outside the fireplace.
- During periods of heavy use, inspect frequently for evidence of sooting. If sooting is present, discontinue use until source of sooting is determined and corrected.
- Maintain positioning of FireBalls, FireShapes or FireStones (Pages 9 thru 18) at all times.
- Occasionally, you may use a soft bristle brush or damp cloth to clean objects.

TROUBLESHOOTING

Safety Pilot Lighting Issues

- Check for loose Thermocouple terminal nut connection.
- Check that pilot flame strikes thermocouple—Adjust as needed.
- Check that Valve Knob is fully depressed during pilot lighting operation and held depressed for 30 to 60 seconds with pilot flame lighted.

Nuisance Shutdown of Burner or Pilot/

Pilot Difficult to Light or Unable to Remain Lighted After Months or Years of Use

Most likely cause: Air intake holes in ODS Pilot have clogged with lint or dust (see Page 20 Figure 34) . During normal operation, air is drawn into these holes to mix with the gas to create a proper pilot flame. Over time, dust and lint in the air accumulates in these holes, and eventually builds up to disrupt proper operation. Note: this is common with all vented free heaters by all manufacturers.

Fix: Clean the ODS Air Intake Holes with compressed air (like that used to clean keyboards) or a pipe cleaner. Perform this cleaning annually or as required to prevent nuisance shutdown.

Burner is Excessively Noisy

Please Note: The movement, mixing of air and gas, and combustion will create a low, throaty sound, which is normal..

Excessive gas pressure: Make sure the gas pressure coming into the fireplace does not exceed the maximum pressure allowed with this gas set (refer to the table on pages 5 and 6).

Passage of air/gas across irregular surfaces: There may be burrs, paint or other blockages on the burner bar ports. Check these ports and remove any blockage.

Gas Connector: Relieve any tight bends or kinks in the Flex Connector. Switch to a smooth aluminum connector, which can be purchased at hardware or home improvement stores.

Burner Flame is Too High (8-12" Above Top Logs) or Too Low (Below Top Logs)

Incorrect gas supply, pressure, or burner orifice used: 1) Ensure gas type of set is proper for gas type being used. Make sure the gas pressure coming into the fireplace falls between the minimum and maximum pressures allowed with this gas set (refer to the tables pages 5 and 6).

Blocked ports (low flame only): Free the main burner orifice and burner bar ports of any burrs, paint or other blockage.

No Spark at Pilot when Depressing Piezo Igniter

Most likely cause: Wire connecting push button with pilot has become disconnected

Fix: Reconnect wire.

Receiver Beeps (SE and RE Models)

Most likely cause: Receiver has become too hot, triggering over-temperature safety feature.

Fix: Move receiver into a cooler area of firebox, onto the hearth, and/or place in accessory RH3 Remote House.

Odor and/or Smoke After Break-in Period (other than Natural Odor of Gas Combustion)

Most likely causes: Lack of fresh air and/or impurities in the room air. Since the appliance is drawing its combustion air from the living area, any odors or impurities present in the room will be recycled through the flame and recirculated back into the room. Such impurities include: pet hair, fresh paint or varnish, paint remover, cigarette smoke, potpourri and incense, cements and glues, new carpet or textiles, dust build-up, and residue from previous wood burning left in the firebox and flue, among other things.

Fix: Add fresh air. Remove sources of impurities.

NOTE—The installation of appliances in a manufactured home (U.S. only) or mobile home installation must conform with the Standard *CAN/CSA Z240 MH, Mobile Housing*, in Canada, or with the *Manufactured Home Construction and Safety Standard, Title 24 CFR, Part 3280*, in the United States, or when such a standard is not applicable, *ANSI/NCSBCS A225.1/NFPA 501A, Manufactured Home Installations Standard*.

HOW TO ORDER PARTS

Parts can be ordered through the supplier from whom you purchased your ALTERNA™ Log Set or from Rasmussen. When ordering parts, please specify;

1. Model number and Serial number of the Burner (available on the Rating Plate).
2. Model number of the objects set.
3. Type of Gas (natural or propane) and control type (ME, RE or SE)

TWO YEAR CONSUMER PRODUCT WARRANTY

The following warranty has been drafted to comply with the MAGNUSON-MOSS WARRANTY ACT applicable to products manufactured after July 4, 1975. It replaces and supersedes any warranty in this package or in any printed literature.

LIMITED WARRANTY:

RASMUSSEN IRON WORKS INC, 12028 E. Philadelphia Street, Whittier California, U.S.A., warrants this Gas Fire Set and accessories against defects in materials and workmanship, and suitable for a particular purpose, for a period of:

- (1) OBJECT CASTING - All logs are guaranteed against burnout in the original installation for 2 years from the date of initial purchase.
- (2) BURNERS, SHEET METAL, SAFETY CONTROLS AND ALL OTHER COMPONENTS - 2 Years from date of initial purchase.

When used in an outdoors or commercial installation, the warranty period shall be six (6) months. Warranty does not extend to corrosion of parts used in outdoor environment.

THIS WARRANTY IS FOR THE BENEFIT OF THE ORIGINAL PURCHASER.

WARRANTY ADJUSTMENT:

- (1) RASMUSSEN agrees to repair or furnish a replacement for, but not remove or install any product or component which proves defective within the above warranty and appropriate time periods stated.
- (2) BUYER notify RASMUSSEN of any defect within this warranty no later than thirty (30) days after a defect is discovered.
- (3) No product will be accepted for return or replacement without written authorization of RASMUSSEN. Before returning merchandise, write to RASMUSSEN Giving us full details of the complaint and a copy of the sales receipt or other evidence of the purchase date. Merchandise returned without proof of purchase date will be serviced out-of-warranty at our prevailing service and parts rates. If merchandise was damaged in transit, the file claim must be addressed as follows:

**RASMUSSEN IRON WORKS INC
12028 E. PHILADELPHIA STREET
WHITTIER, CALIFORNIA 90601**

**Shipping charges must be pre-paid by the buyer.
REPAIR OR REPLACEMENT UNDER THIS WARRANTY
WILL BE SHIPPED FREIGHT COLLECT.**

EXCLUSIONS FROM WARRANTY:

- (1) The foregoing warranty is limited solely as set forth herein and applies only for the designated above.
- (2) RASMUSSEN shall not be liable for any loss, damage incidental or consequential damages of any kind, whether based upon warranty, contract, or negligence, arising in connection with the sale, use or repair of the product. Some states do not allow the exclusion or limitation of incidental or consequential damages, so the above limitation or exclusion may not apply to you.
- (3) The maximum liability of RASMUSSEN in connection with this limited warranty shall not in any case exceed the contract price paid for the product claimed to be defective or unsuitable.
- (4) This warranty does not extend to any product manufactured by RASMUSSEN which has been subjected to misuse, neglect, accident improper installation, or use in violation of instructions furnished by RASMUSSEN. Do not remove Rating Plate/Warning Tags. These tags serve you and any future user as an integral Safety and identification component of the CHILLBUSTER gas log heater. Removing these tags voids the warranty.
- (5) This warranty does not extend to or apply to any unit which has been repaired or altered in any place other than RASMUSSEN IRON WORKS INC. factory, or by persons not expressly approved by RASMUSSEN.
- (6) Components manufactured by any supplier other than RASMUSSEN shall bear only that warranty made by the manufacturer of that product.
- (7) Freight damage, cracking from thermal shock, and color changes occur from causes beyond manufacturer's control and are not covered by any warranty.

THIS WARRANTY GIVES YOU SPECIFIC LEGAL RIGHTS, AND YOU MAY ALSO HAVE OTHER RIGHTS WHICH VARY FROM STATE TO STATE.

RASMUSSEN IRON WORKS, INC. shall be held harmless from any and all claims by the buyer as a result of injury or damage to an ultimate user or other person caused by the product sold herein by the seller to the buyer, whether the injury or damage results from the assembly, product installation, operation, shipment, storage or manufacture of this product. RASMUSSEN IRON WORKS, INC makes no warranties, expressed or implied, other than those expressly stated herein.

CONSUMER RECORD CARD

FOR CUSTOMER RECORDS ONLY.
DO NOT SEND THIS CARD TO MANUFACTURER



LOG MODEL: _____

SAFETY CONTROL: _____

DATE OF PURCHASE: _____

DEALER: _____

INSTALLER: _____